

# HOMEBIOGAS<sup>®</sup>

HBG 2.0 HOUSEHOLD BIOGAS SYSTEM

## OWNER'S MANUAL

VERSION 110822



Introduction	3
Safety	5
System Assembly	6
Activating the System	32
Daily Operation	34
System Care	38
Troubleshooting	40
Tech Specs	44
Homebiogas Fertilizer	45
Warranty	46

# introduction

The HOMEBIOGAS household biogas system turns organic waste like food scraps and animal manure into biogas, which can be used for cooking, and natural liquid fertilizer, which can be used for gardening.

Biogas is generated in the system by the anaerobic (without oxygen) fermentation of organic matter. Biogas is a flammable gas that is lighter than air, composed mainly of methane and carbon dioxide.

HomeBiogas is a biological system: performance is affected by environmental conditions and may vary due to physical location and ambient temperature.

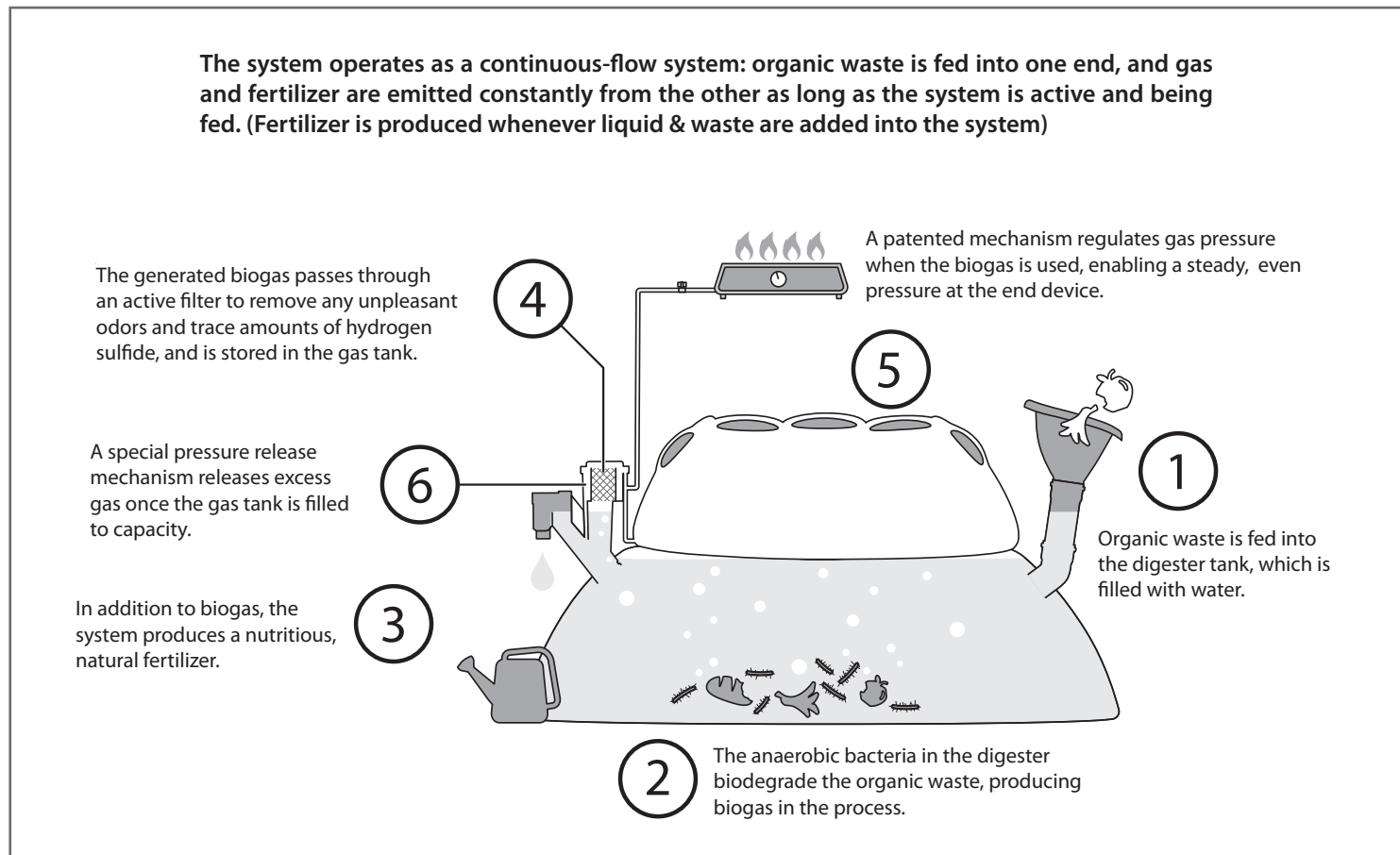

# main parts of the system

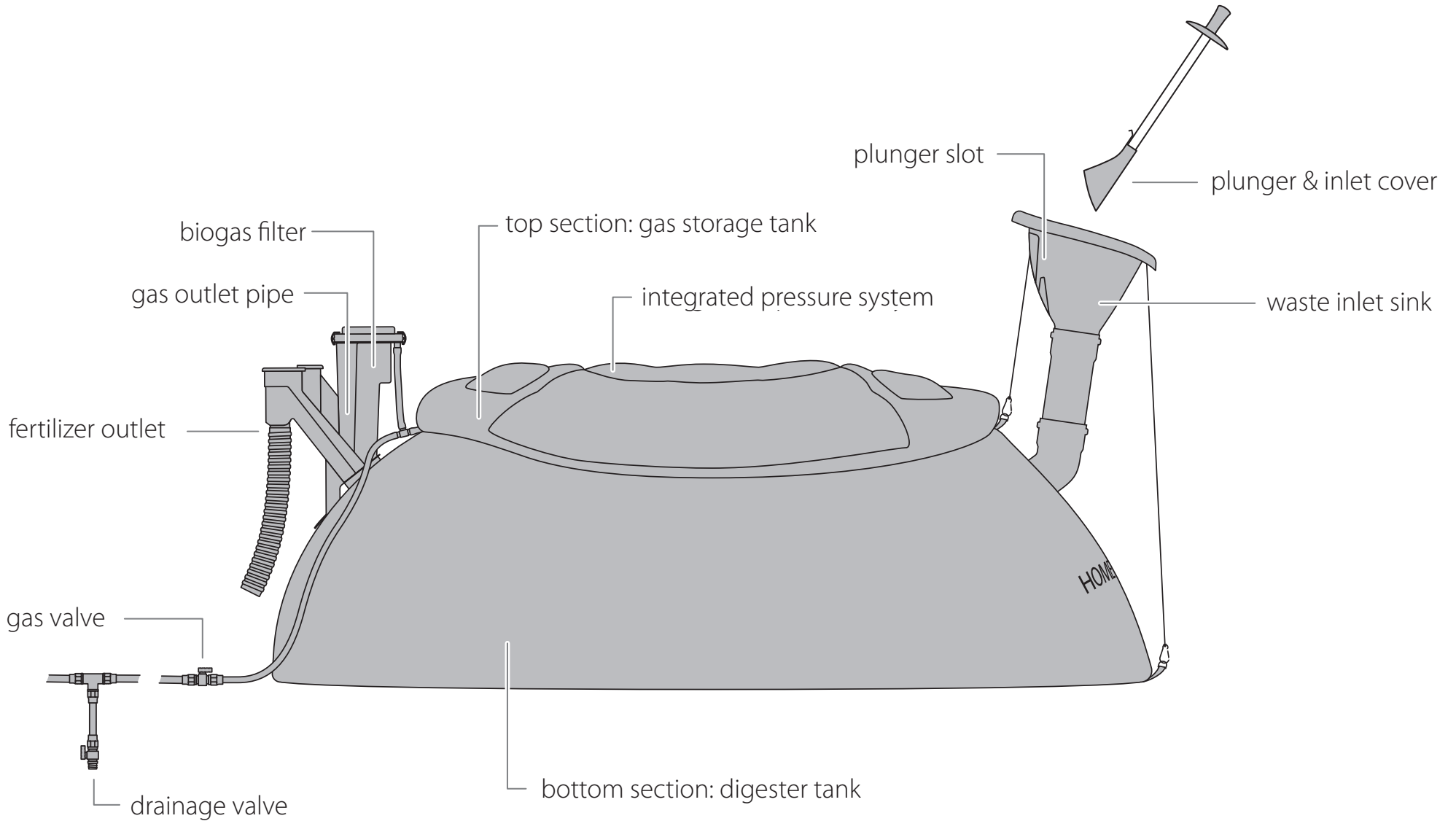

# safety

**Biogas is a flammable gas. Always observe these precautions to prevent accidents:**

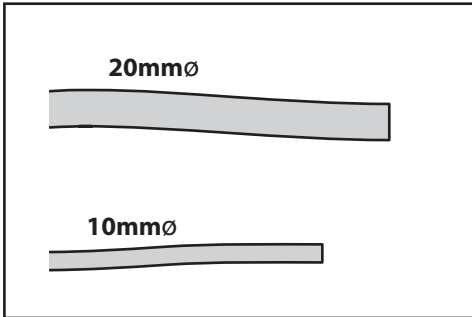

Only use gas tubing with the right diameter. Contact Homebiogas if you need more information.

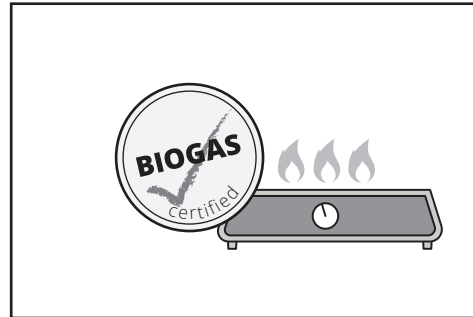

Use only devices compatible with or adapted for biogas use. Visit [homebiogas.com/faq](http://homebiogas.com/faq) to find out how to adapt a stove for biogas use.

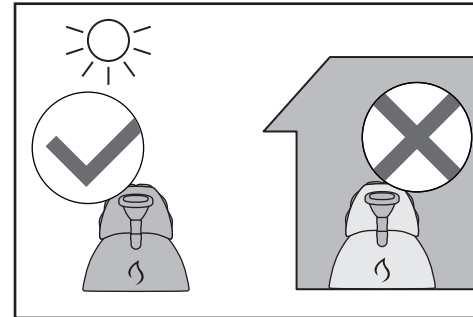

Only install system outdoors so excess gas can be released safely.

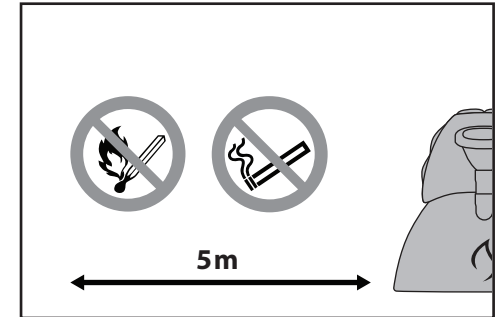

No open flames or sparks within 5 meters (15 ft.) from the system.

## other safety precautions:

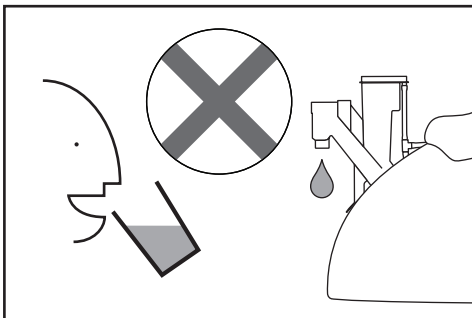

Do not drink the liquid effluence.

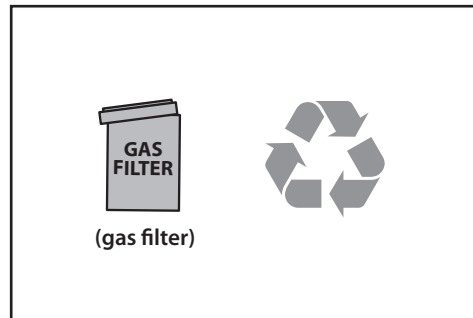

Dispose of used gas filters safely – refer to page 39 for details.

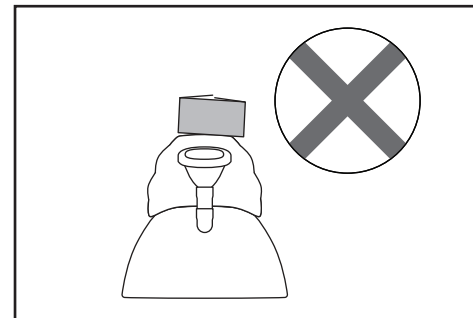

Do not place any object on top of the system.

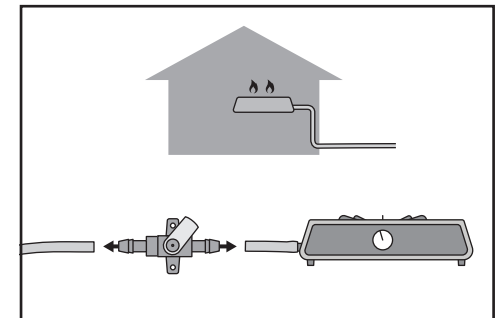

Purchase and install a safety valve when using devices indoors. (Not included in assembly kit)

# system assembly

Scan QR for a step-by-step video of the assembly process.  
(Link to video:  
[youtu.be/SgBv23FT2AM](https://youtu.be/SgBv23FT2AM))



## From Assembly to Usage:

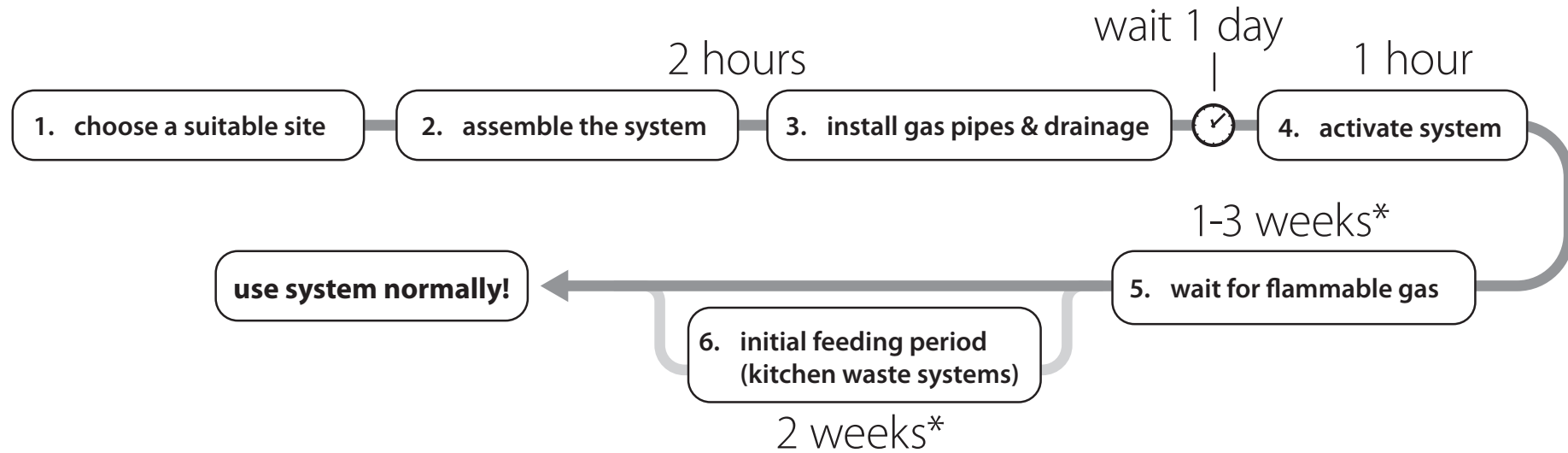

\*5. continue feeding the system manure as per activation instructions (page 30). you may start trying to light the gas as soon as the gas tank has visibly started to fill

\*6. for manure-only systems, there is no initial feeding period and you should continue feeding throughout the activation process (step 5.)

## Equipment Needed

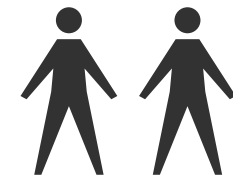
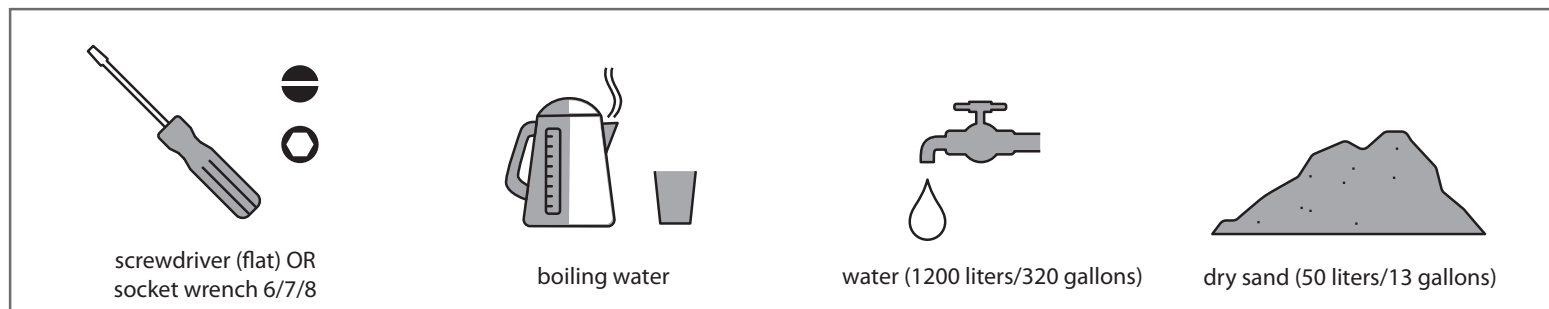

Assembly with 2 persons  
recommended

## site selection & preparation

It is important to choose and prepare the right spot for your HomeBiogas system before installation to ensure optimum performance and avoid potential damage to the system.

The system is not designed to be moved or repositioned after it has been filled.

**Failure to set up the system according to the following instructions could void the HomeBiogas warranty.**



**CAUTION: Ensure that the following conditions are met when choosing a location.  
The system weighs more than 1400kg (3100lbs) when filled and cannot be moved after installation!**

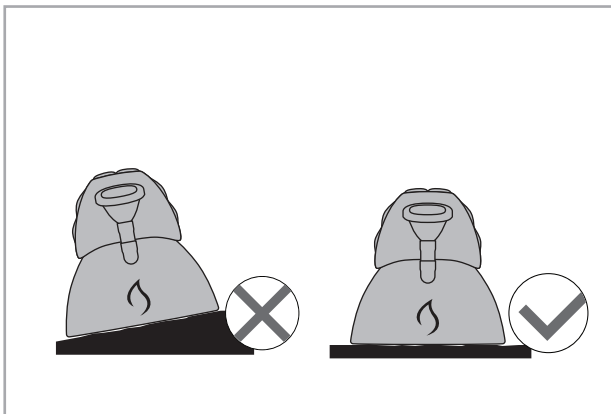

make sure the chosen location has a level surface - usage on sloping or non-level ground will damage system

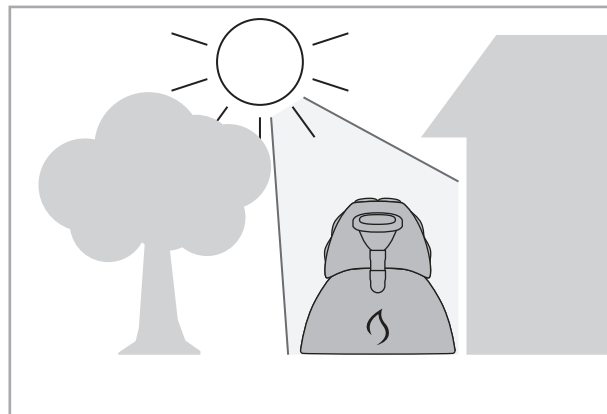

system should be installed in a sunny area outdoors for optimum gas production

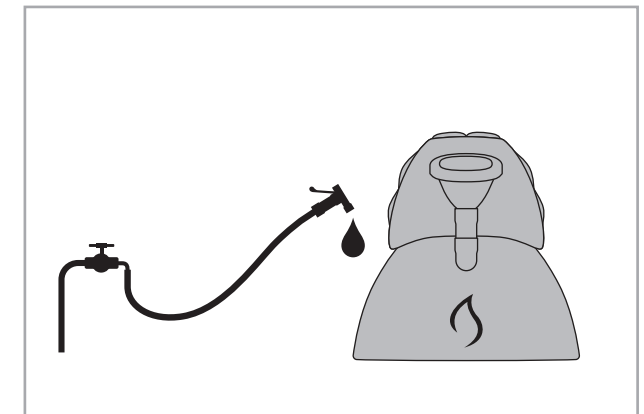

system may have mild organic scent - place away from windows/doors/outdoors seating

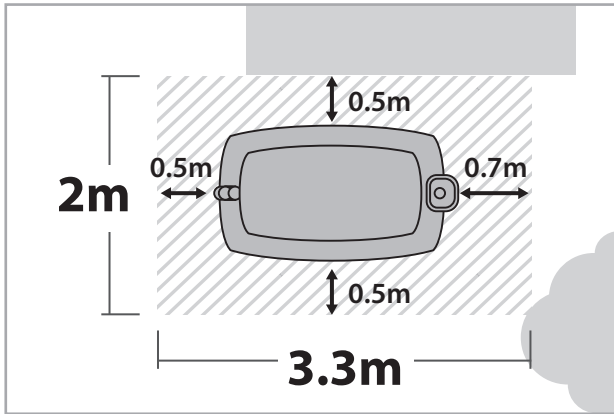

prepare at least 2 x 3.3m (6.5 x 11 ft) space for the system  
(0.5m side, 0.7m front clearance for maintenance & daily usage)

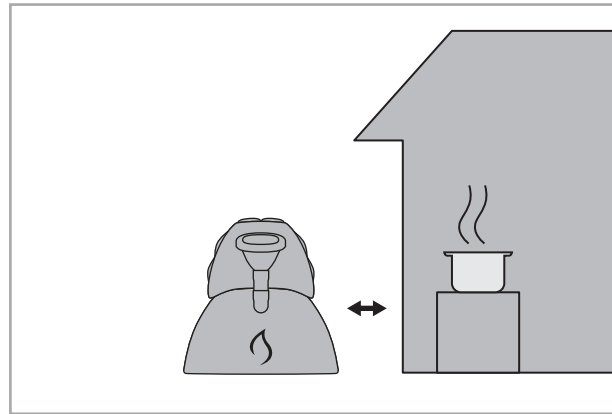

system should be installed close to kitchen/cooking area

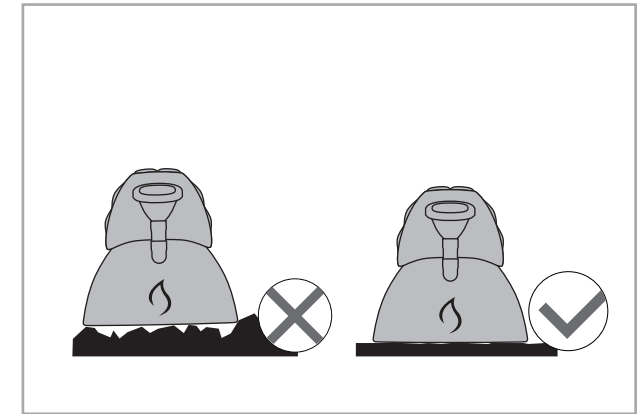

prepare a firm, flat surface clear of obstructions - do not place on soft or unstable ground  
e.g. flat dry ground, tile, concrete

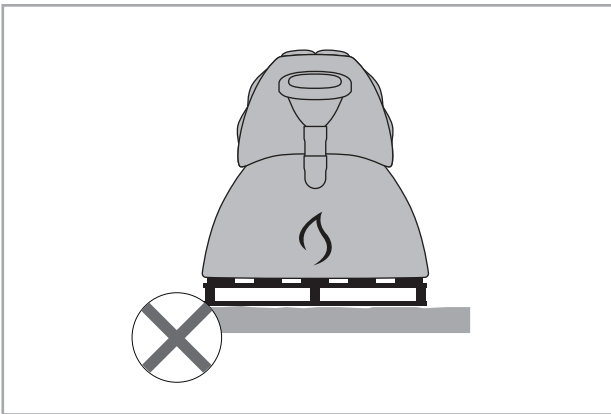

do not place system on shipping pallets or other weak raised surfaces

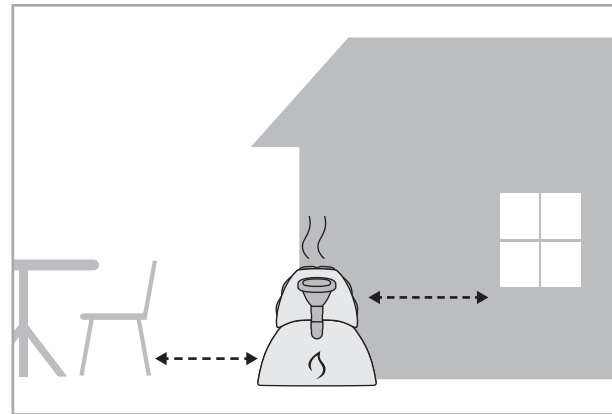

place system within reach of a water supply.



## preparation for gas pipe installation

The system can be connected to a stove/appliance up to 20m (65ft) away (only 10m/33ft gas tubing provided). Plan a suitable route for the gas pipe to ensure optimum gas flow and prevent damage to the pipe - follow detailed instructions for gas pipe and drainage valve installation on page 26, after assembling system.

### Installation options:

1. Gas pipe installed underground - passed through protective PVC pipe



3. Gas pipe fixed onto wall or nearby structure

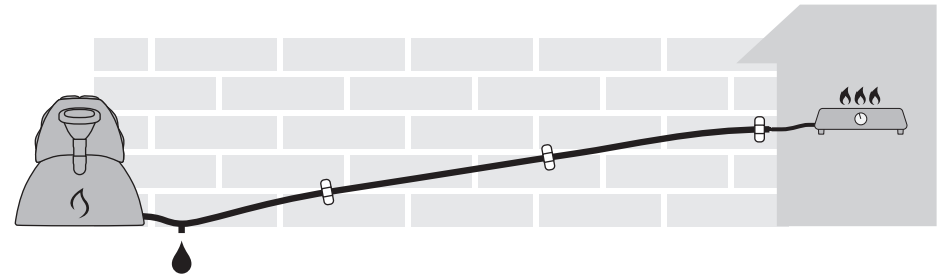

2. Gas pipe above-ground



4. Gas pipe suspended on overhead line

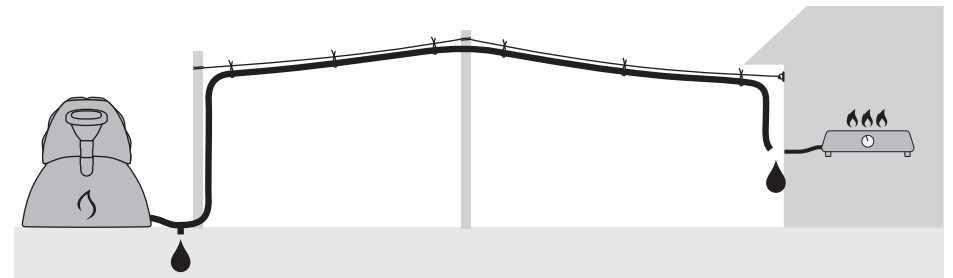

### Installation options:

There should be no U-shaped bends along the pipe, where water will collect and block gas flow.

Gas pipes should be installed at a slight angle across their entire length, with a drainage valve installed at the lowest point for removal of collected condensation.

# system parts (Box B)

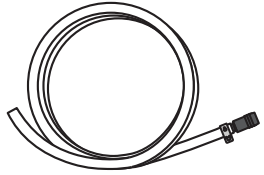

10mmø (3/8") indoor gas tubing with  
20mmø (3/4") connector attached, 3m (10ft)

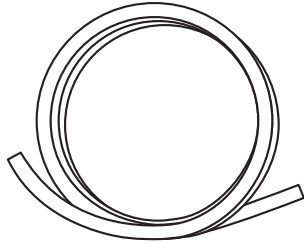

20mmø (3/4") outdoor gas tubing, 7m (23ft)

gas filter



fertilizer  
outflow pipe



combined fertilizer  
& gas outlet

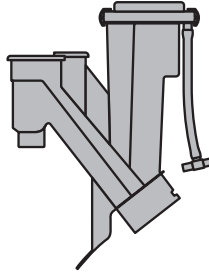

gas outlet  
connecting pipe



sink & inlet pipe  
assembly

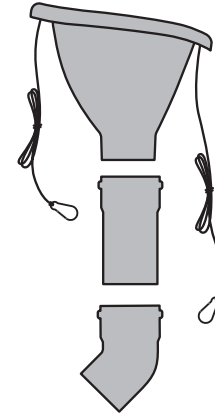

plunger

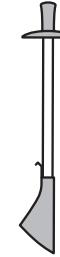

# combined gas tank + digester (Box A)

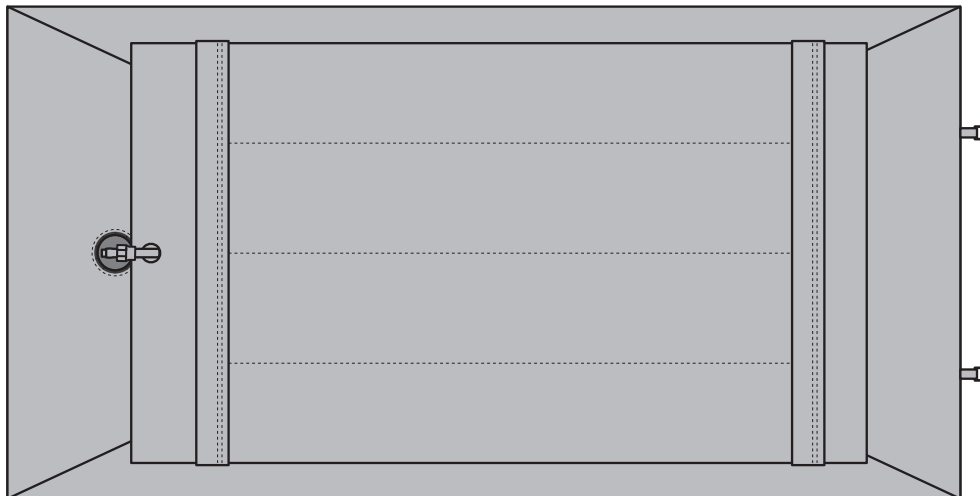

combined gas tank & digester

## parts bag 1

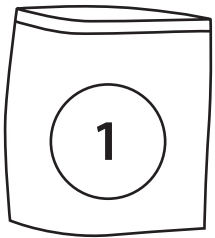

x4

110mm (4") lip seal rubber ring

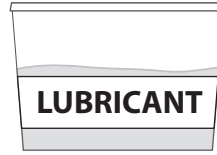
pipe/tubing joint  
lubricantgas tank  
sand-packs

x40

## parts bag 2

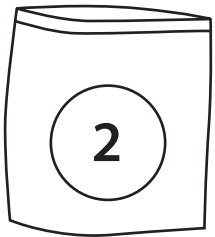
band for 10mm  
( $\frac{3}{8}$ " ) gas tubing

x7

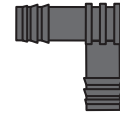
bands for 20mm  
( $\frac{3}{4}$ " ) gas tubing20mm  $\varnothing$  ( $\frac{3}{4}$ " ) gas  
tube straight &  
L-connectors20mm ( $\frac{3}{4}$ " ) gas tube screw connector & fitting

x2

20mm ( $\frac{3}{4}$ " ) gas tube wall clamps & stakes

x2

## drainage kit

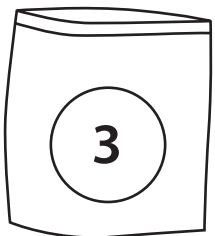

x4

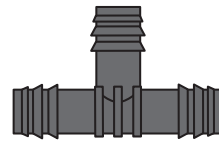
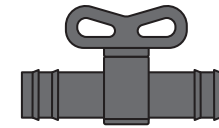
bands for 20mm  
( $\frac{3}{4}$ " ) gas tubing20mm  $\varnothing$  ( $\frac{3}{4}$ " ) T-joint20mm  $\varnothing$  ( $\frac{3}{4}$ " ) ball valve

8cm (3" ) gas pipe



HomeBiogas logo is located at the  
**FRONT** end of the system

**back**  
(gas, fertilizer out)

**front**  
(input sink, waste in)

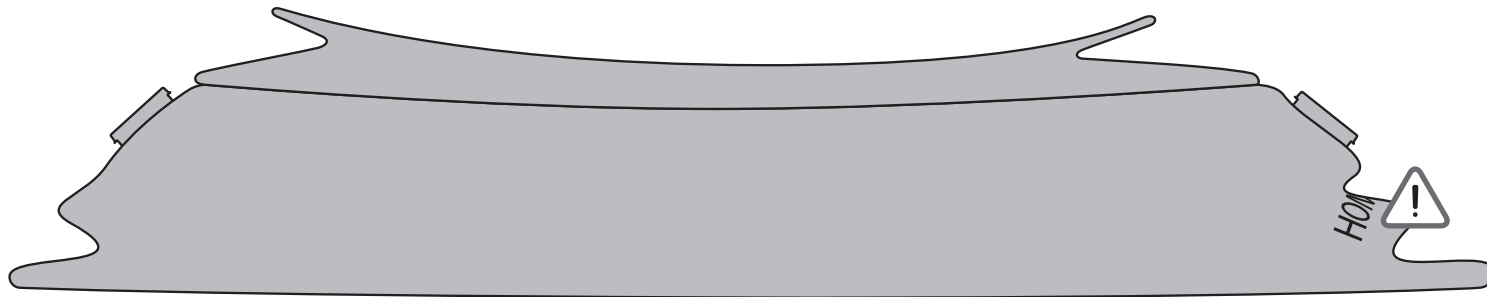

**i**

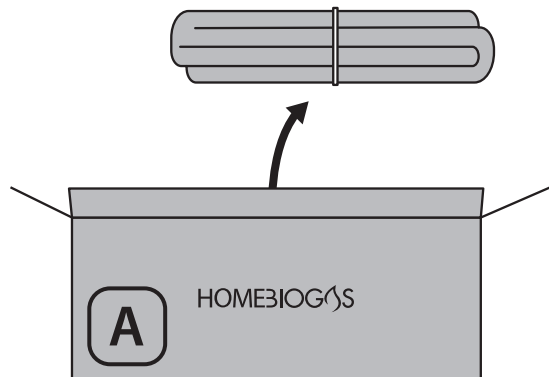

**ii**

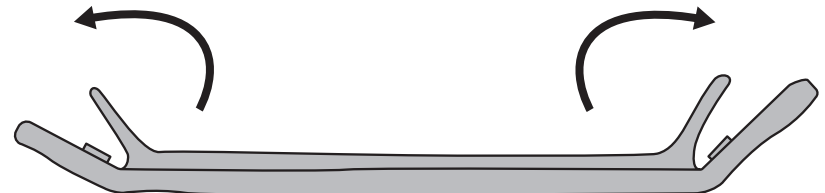

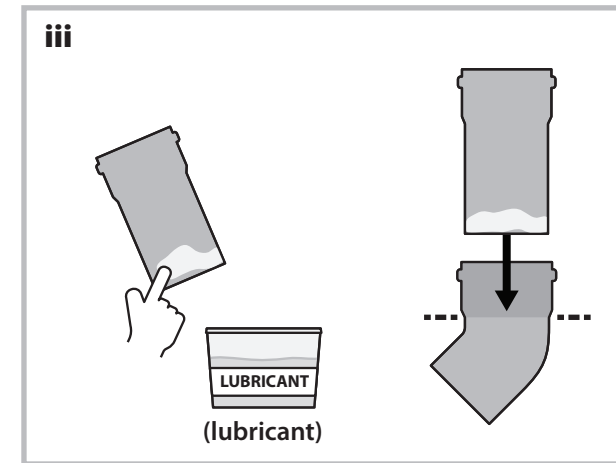
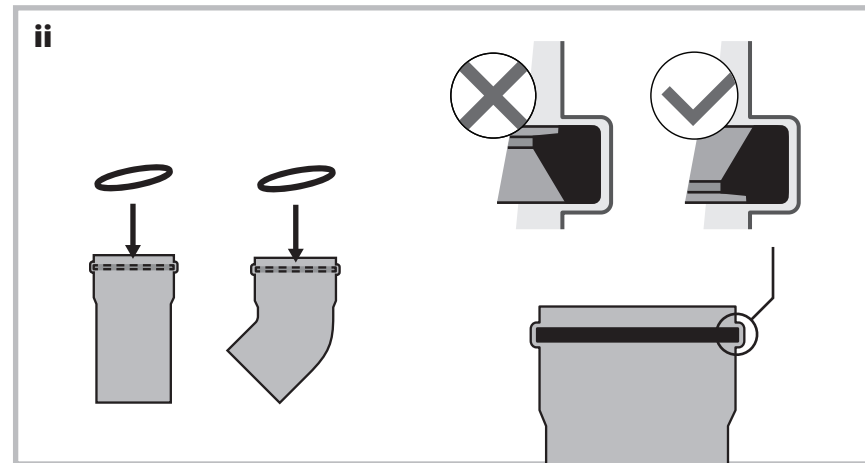
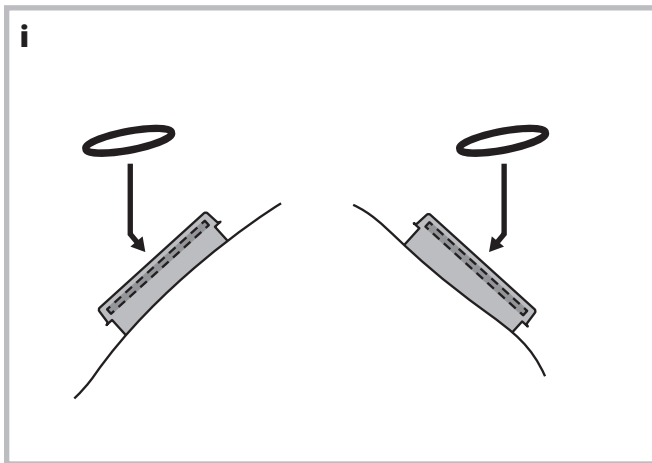
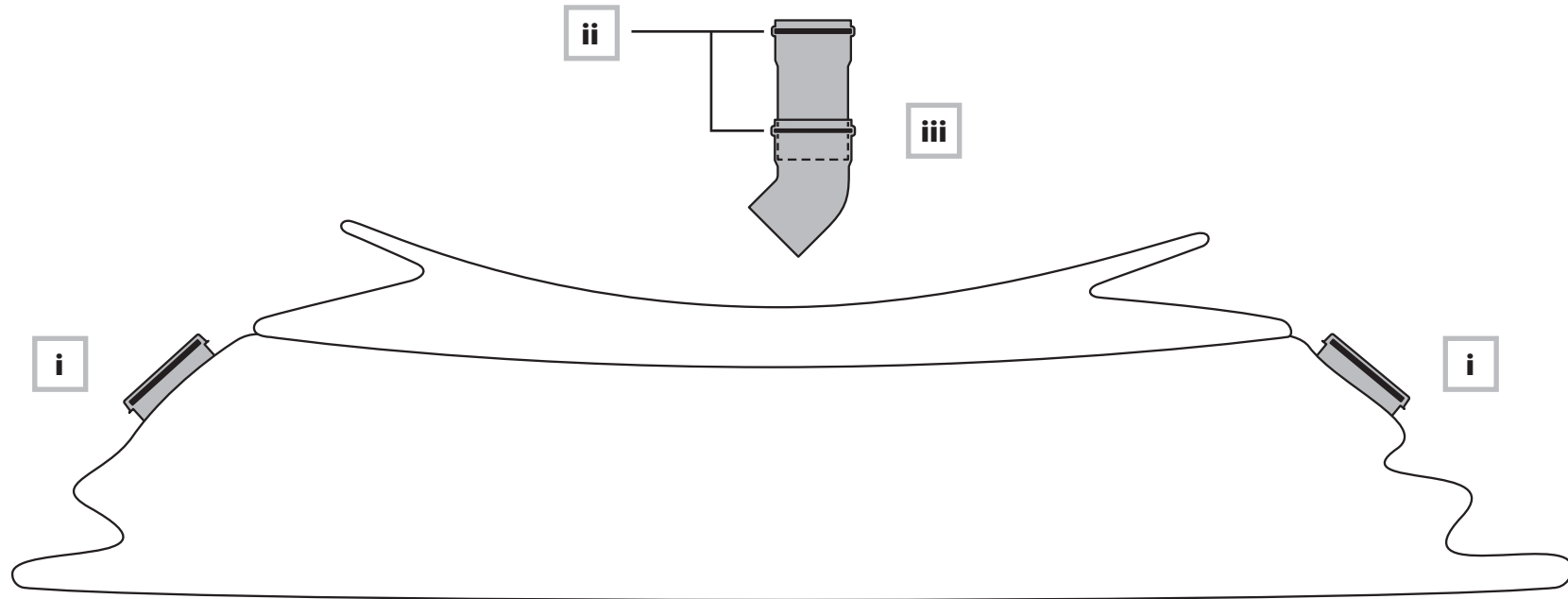
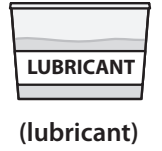



**Improper installation of inlet pipe & combined outlet in the HomeBiogas system can damage the digester's inner liner, causing a leaking digester tank when filled with water. Follow the steps below to properly insert the pipes, to prevent damage and ensure a functioning system.**

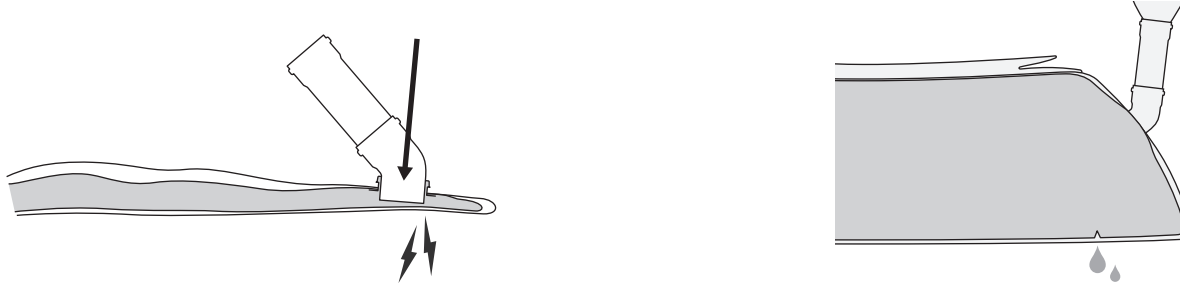

- i.** Check that there is a protective cardboard layer between the pipe connector openings and the digester's inner lining. Contact Homebiogas support if this cardboard protector is missing.

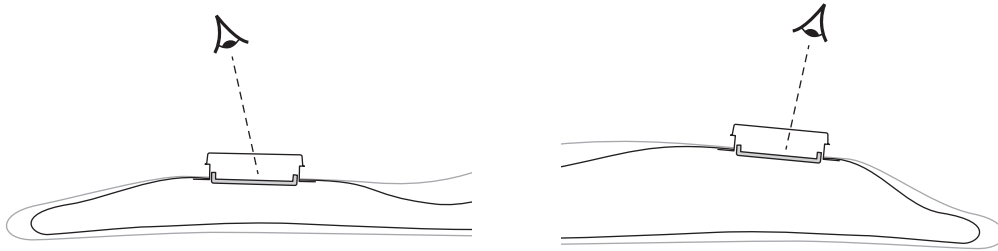

- ii.** Lubricate the pipes, align and insert each pipe firmly with the digester on a flat, hard surface. The cardboard protectors will prevent damage to the inner liner.

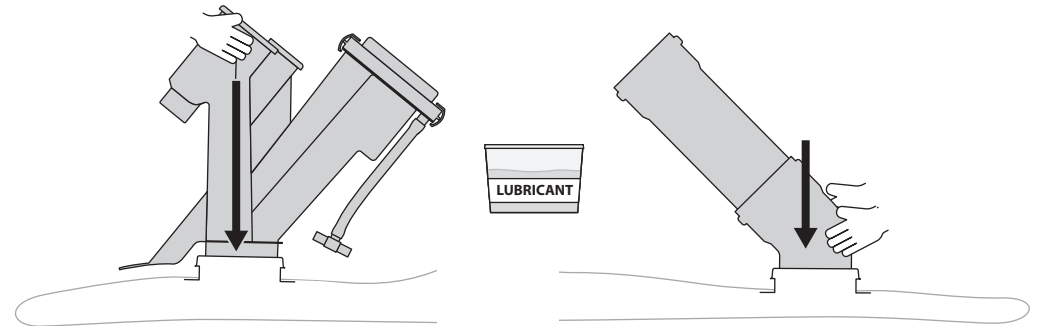

- iii.** Combined Outlet Pipe: Hold onto the rim of the pipe connector with both hands, use the thumbs to push the outlet pipe in all the way.

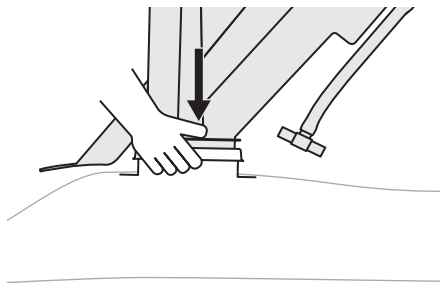

Inlet pipe: Hold onto the folds of the digester fabric around the pipe, support the mouth of the pipe against your body, and push the pipe all the way into the connector. Take care not to push the pipe against the inner liner!

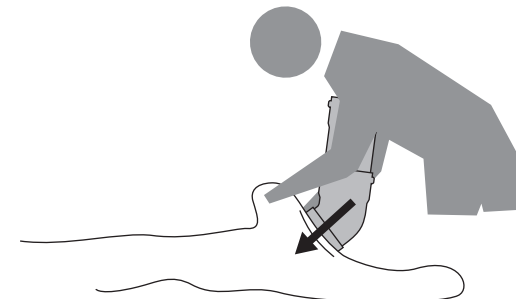



parts bag



(lubricant)

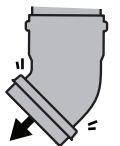
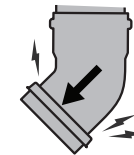
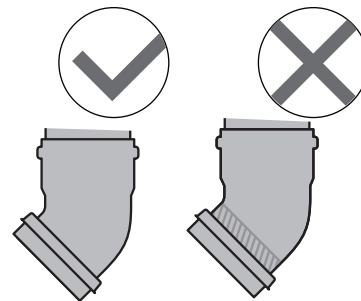
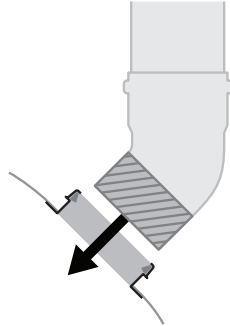
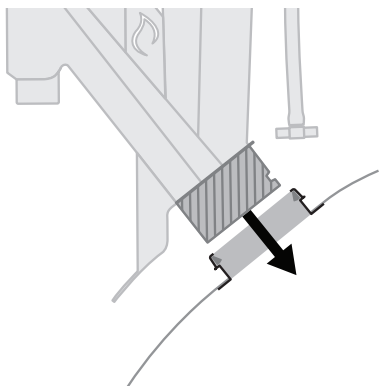
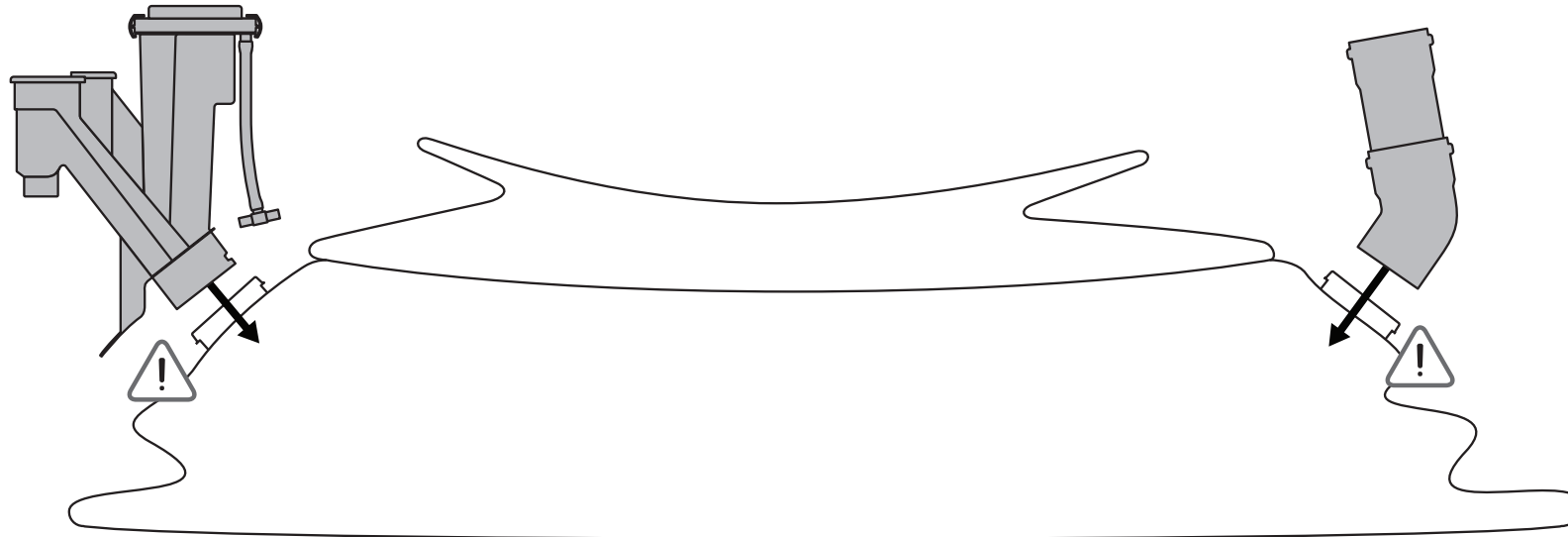



**Inlet sink orientation:**

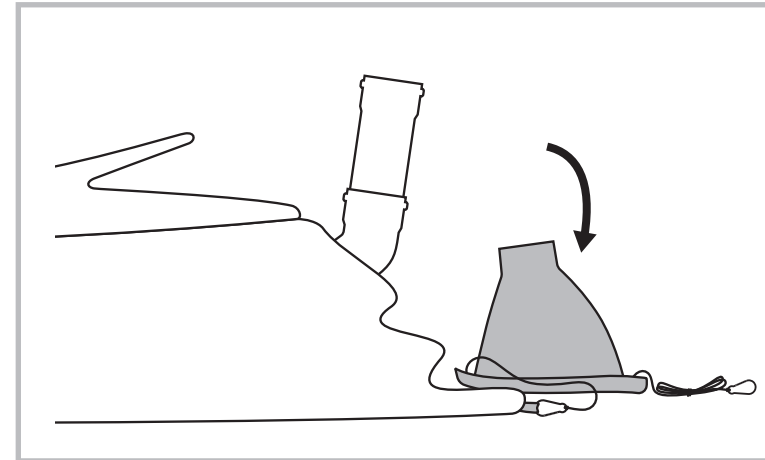
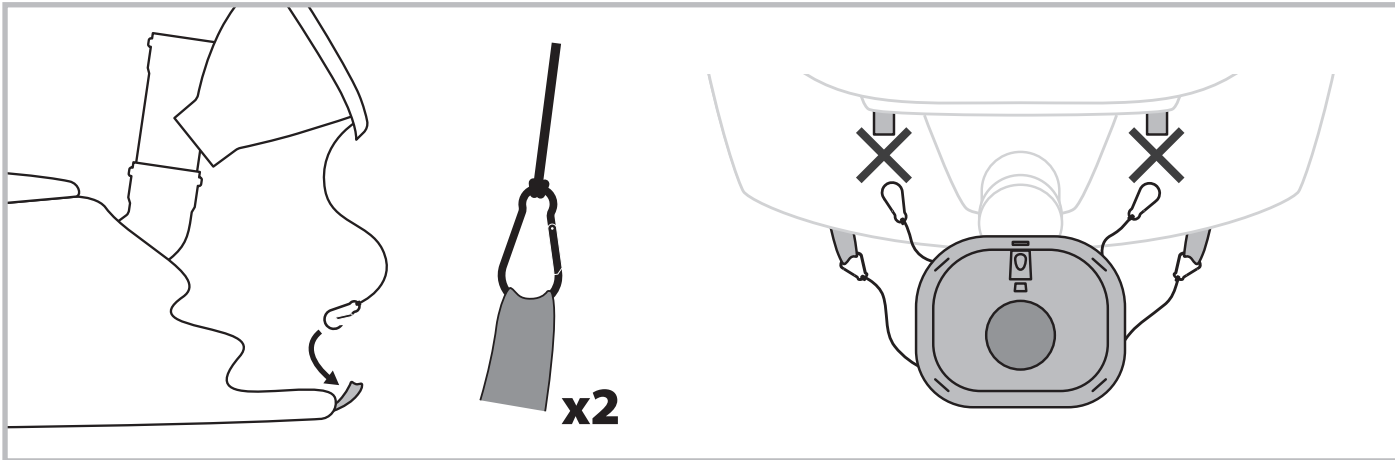
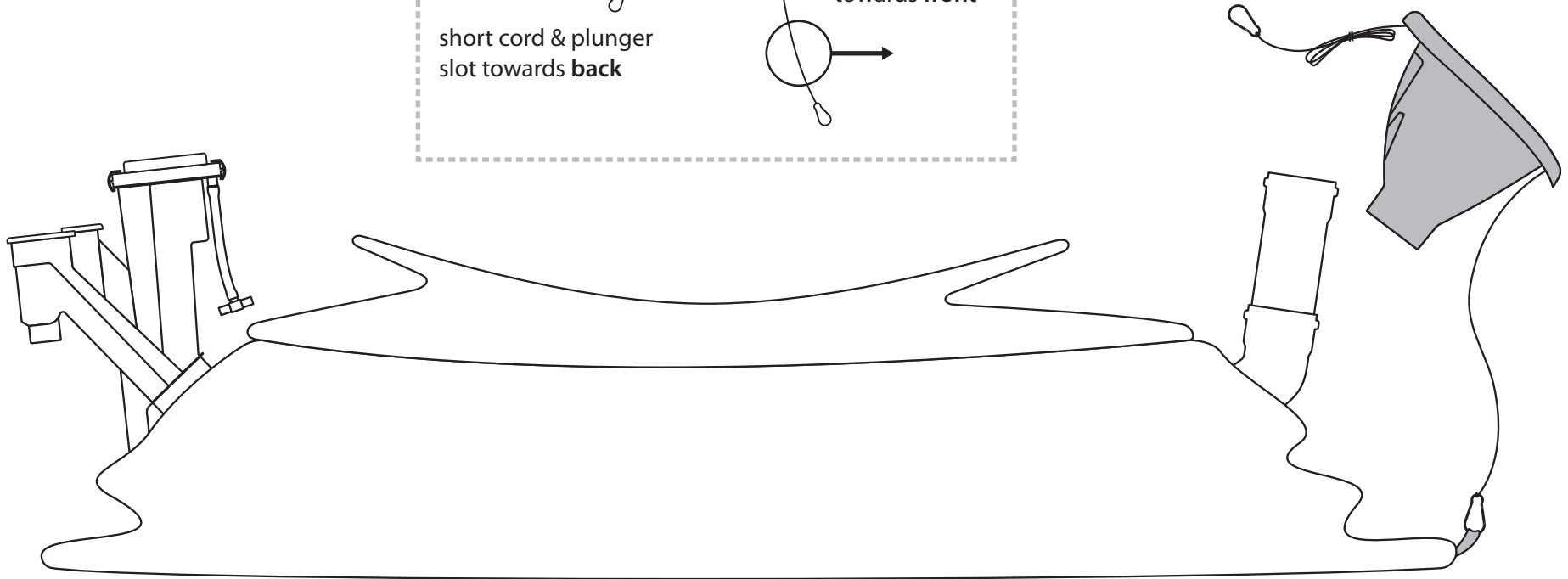
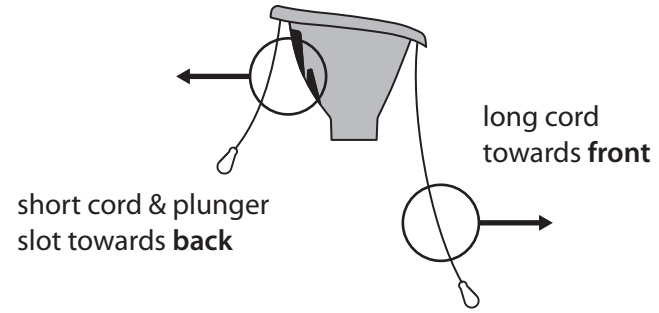





Before filling the digester, make sure it is in a suitable location, chosen according to the site selection criteria in page 7-8.

The digester must be placed on a flattened, level surface!

**back**  
(gas, fertilizer out)

**front**  
(input sink, waste in)

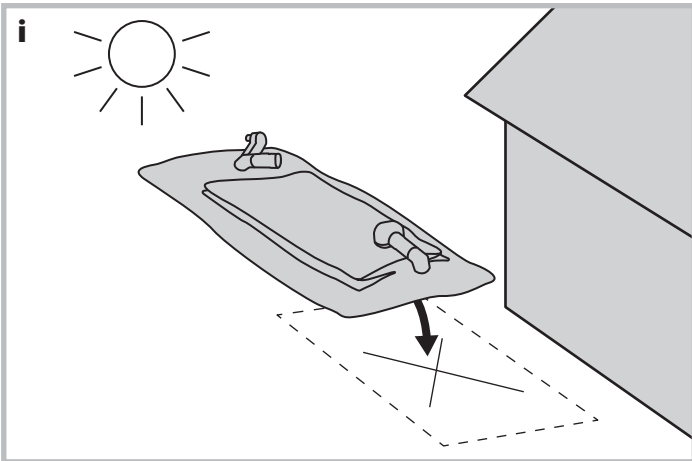
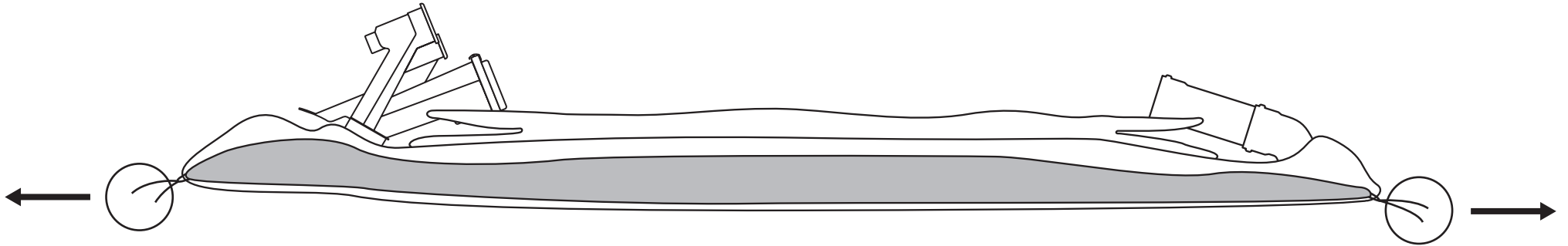

**ii** with another person's help, stretch out digester inner lining with the 4 corner strings

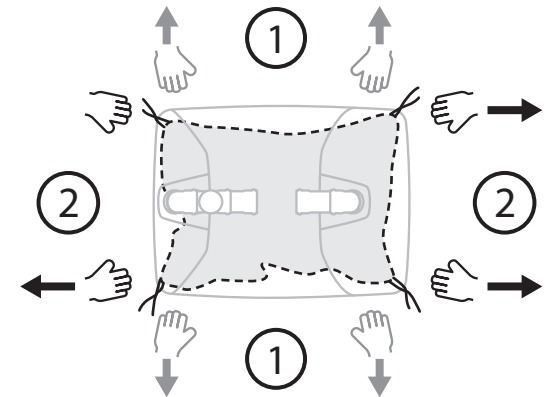



- \* pipes must point inwards when filling
- \* rest hose on digester & enter inlet pipe from opposite side
- \* if not using tap water: pH must be between 6.5 and 8.5

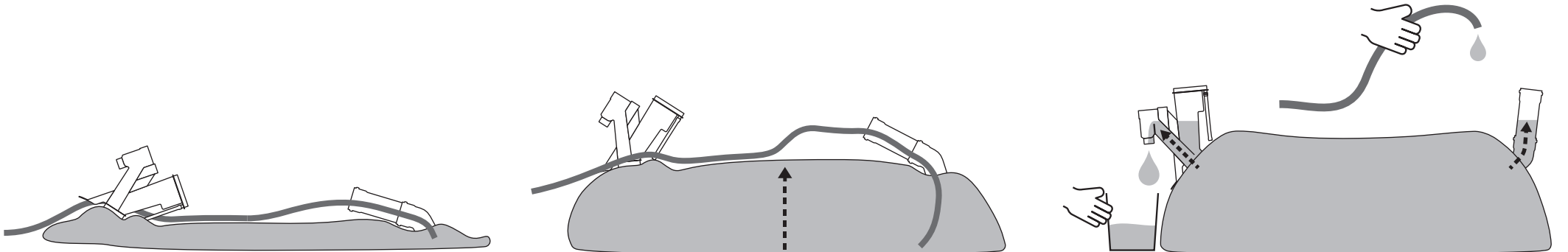
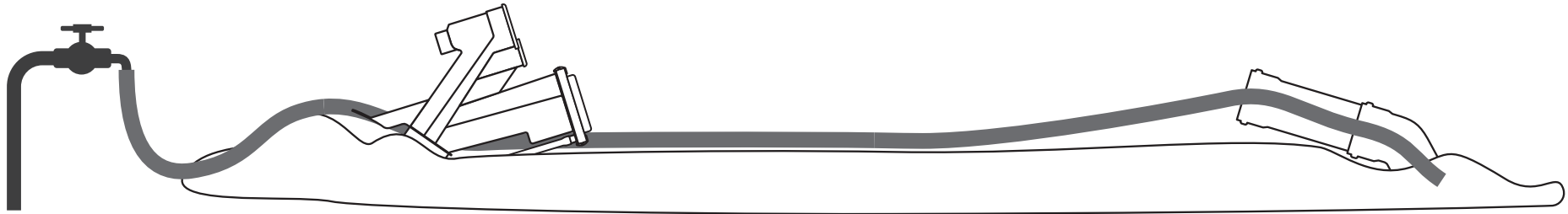
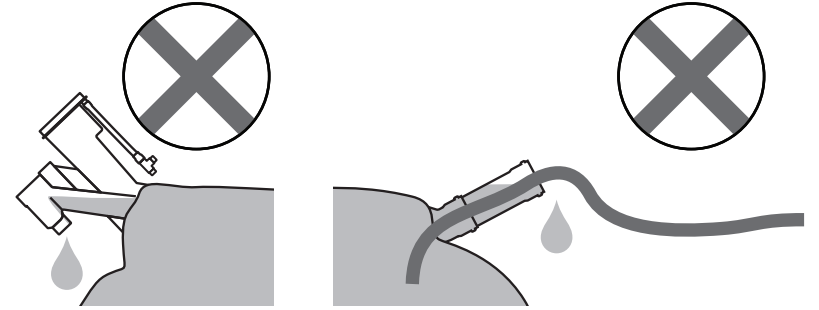
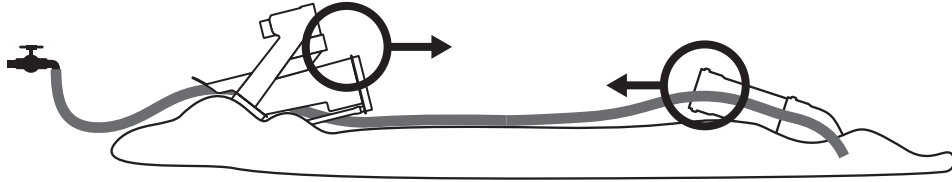

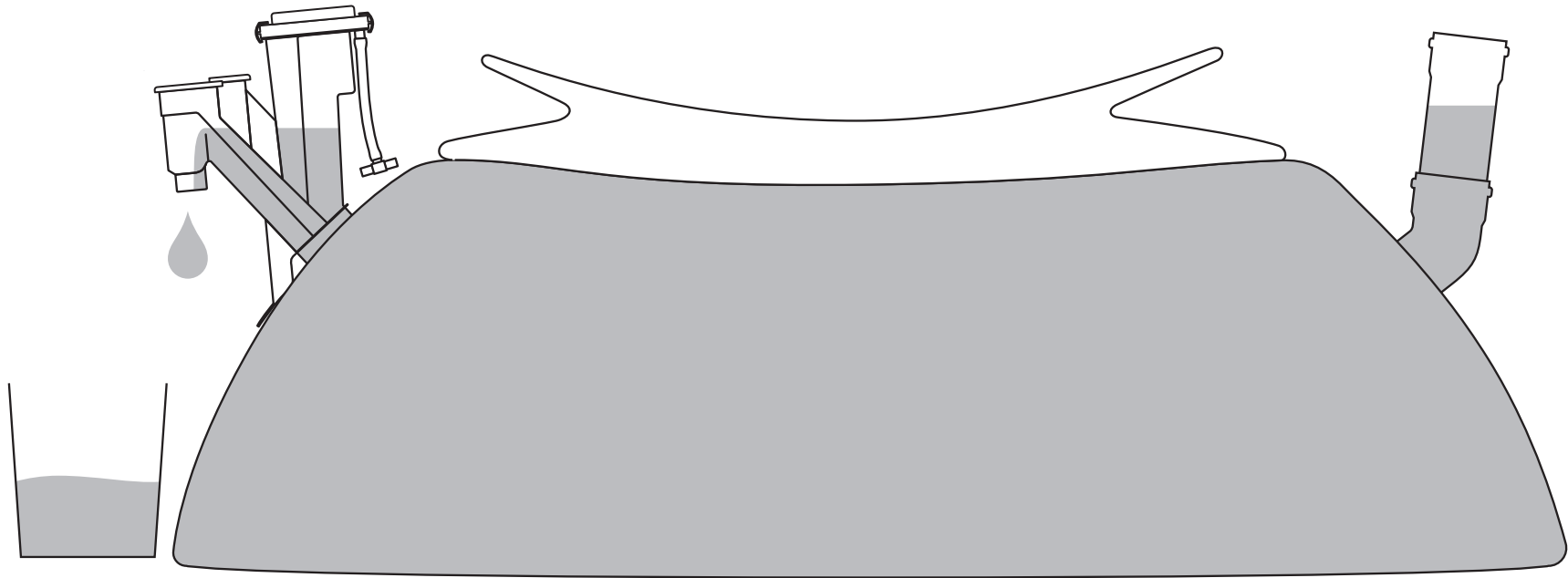

**check filled digester for leaks.**

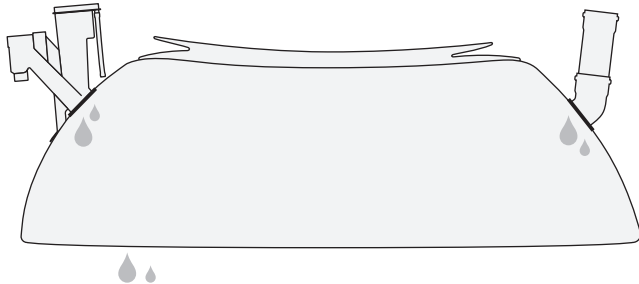

**contact HomeBiogas if any leaks are seen.**



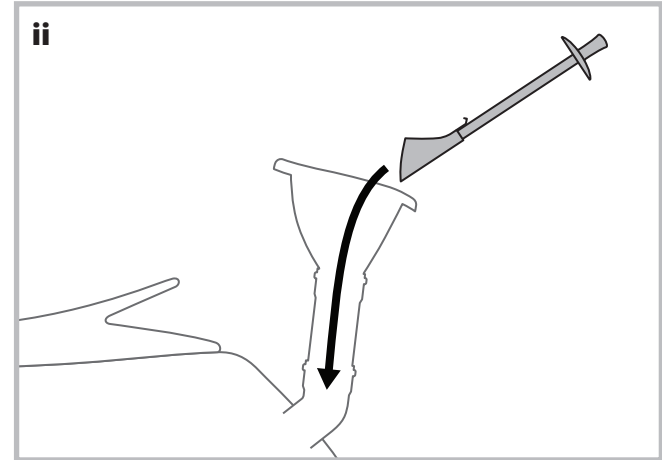
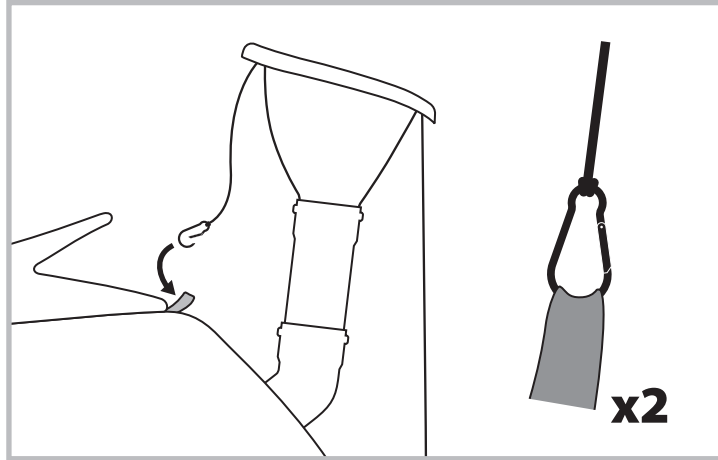
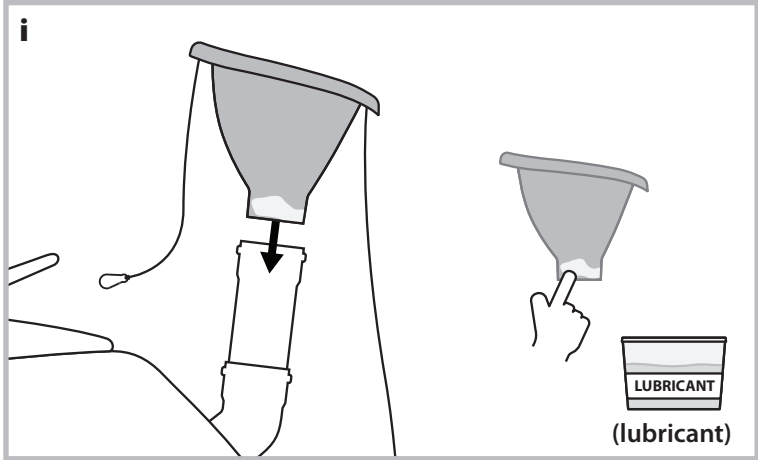
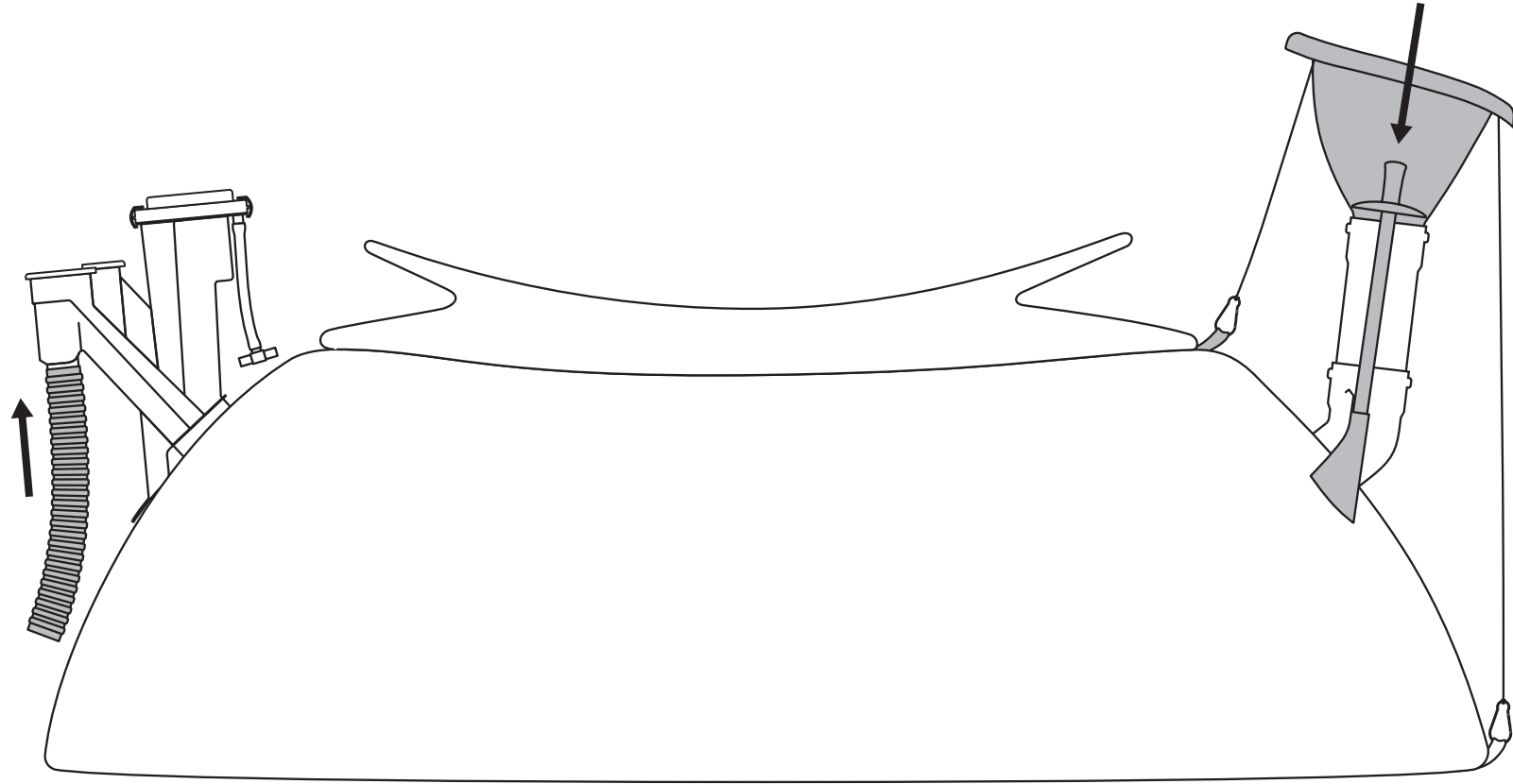

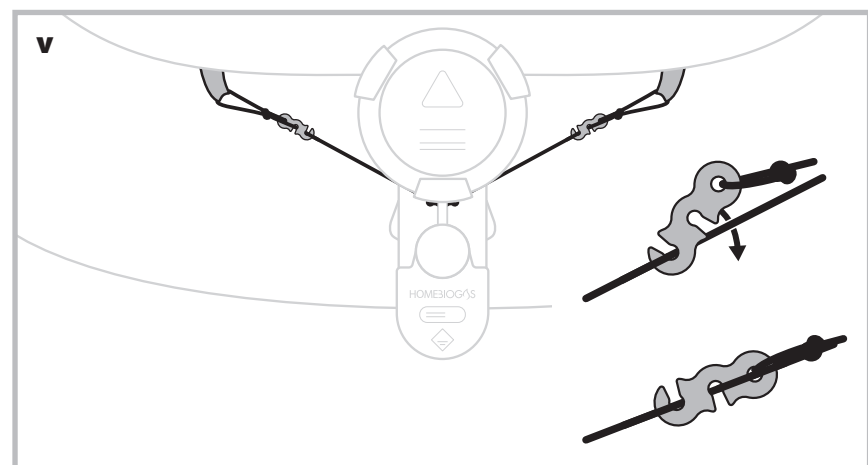
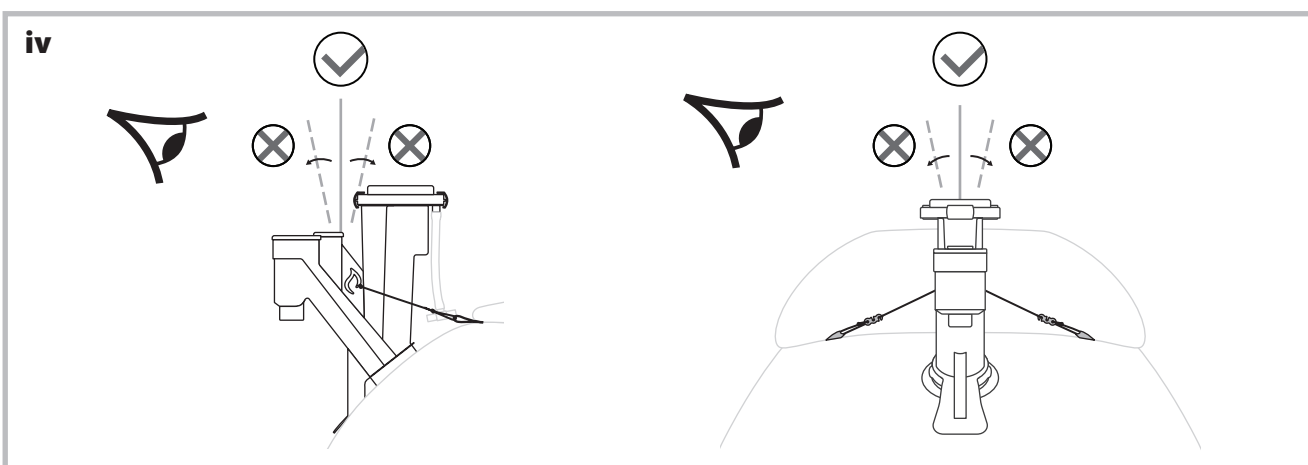
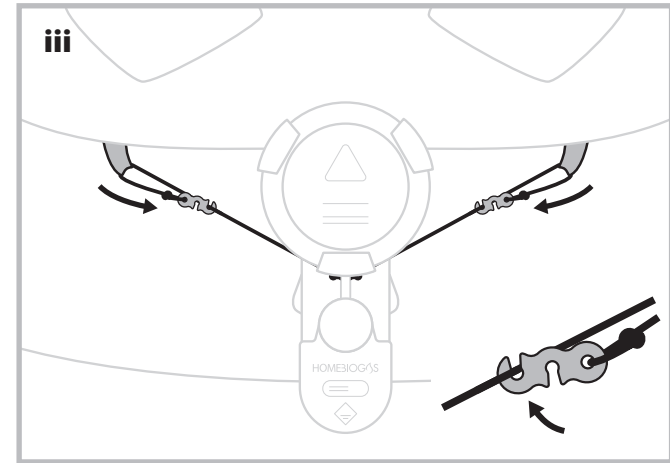
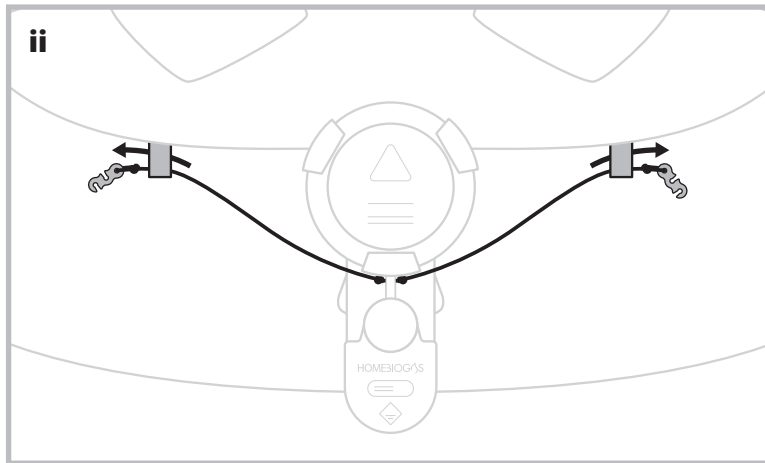
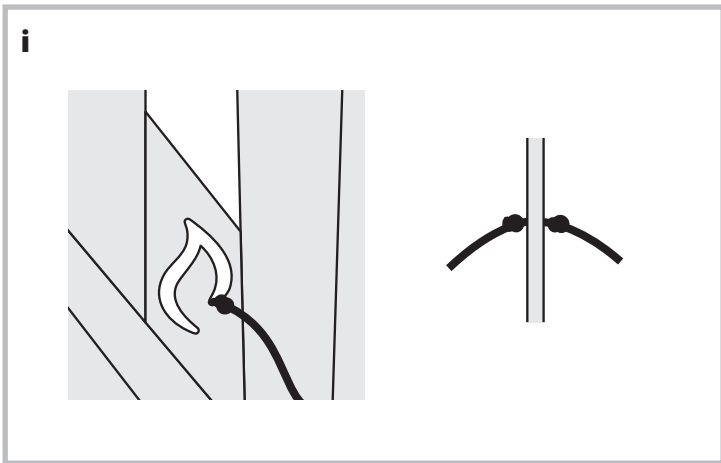
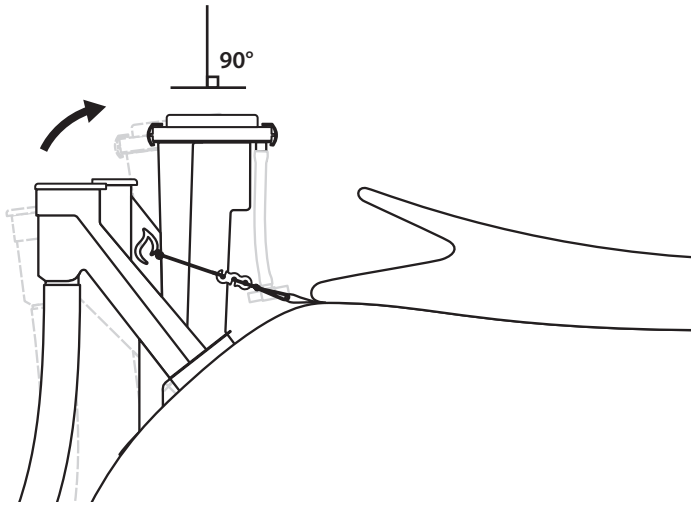

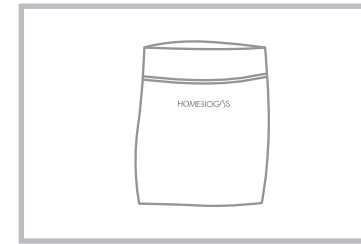

sand bags



use dry sand only

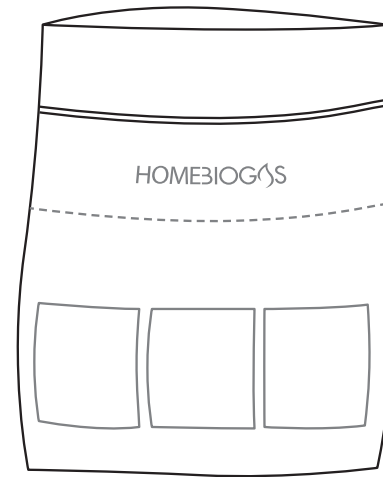
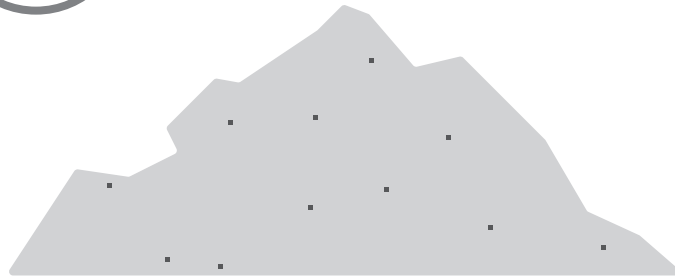

x40

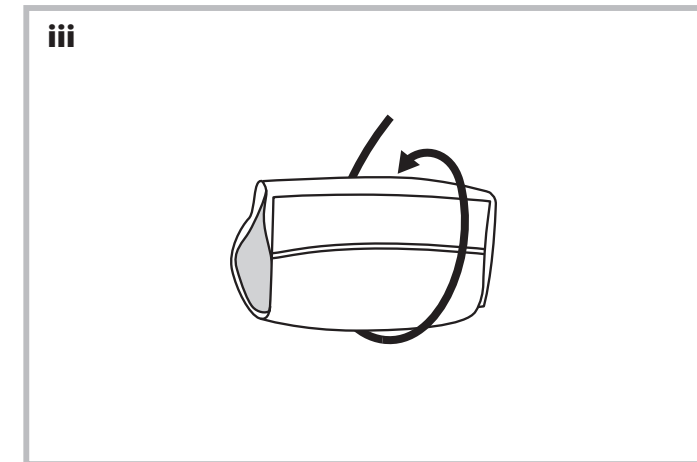
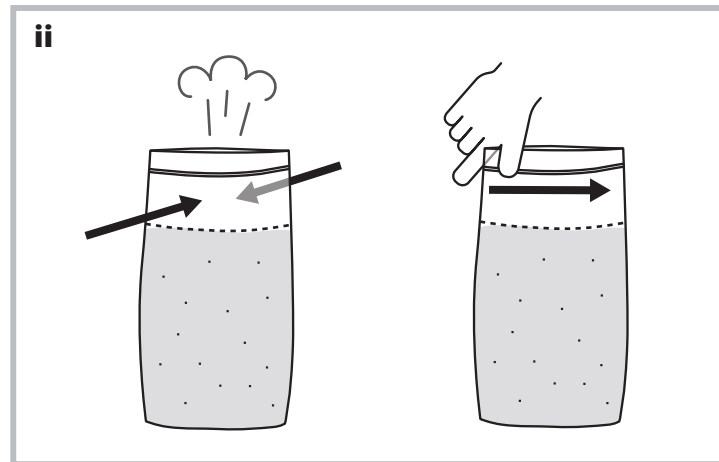
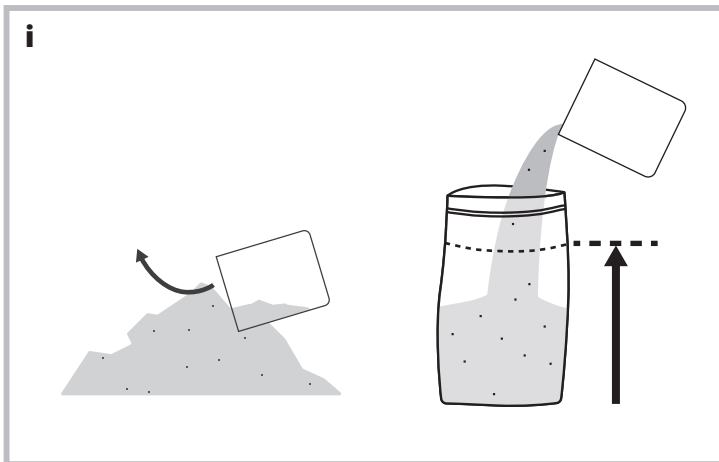

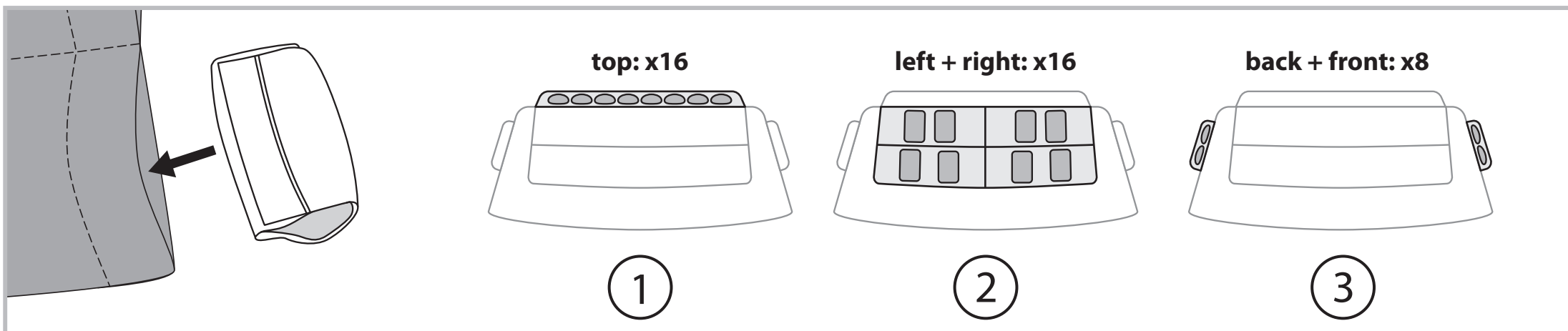
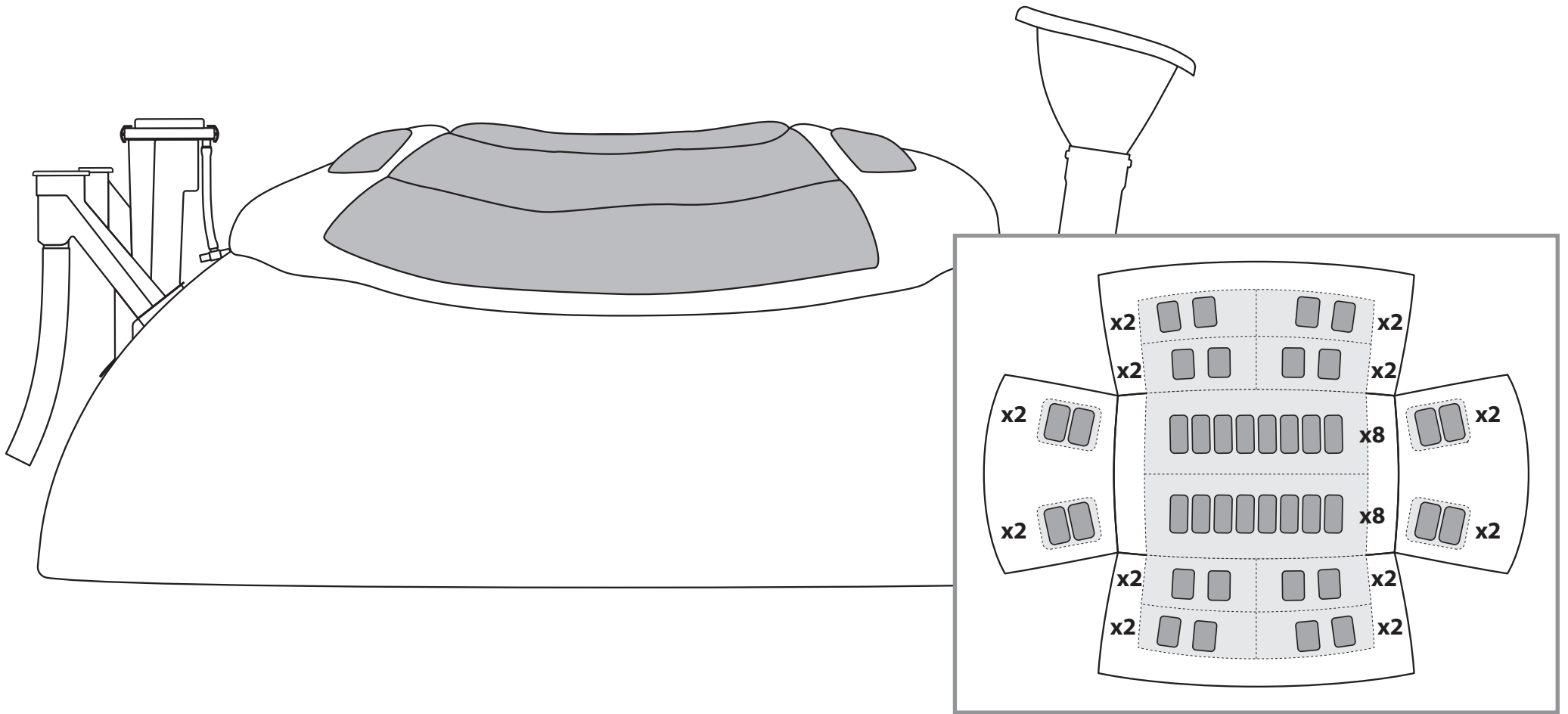

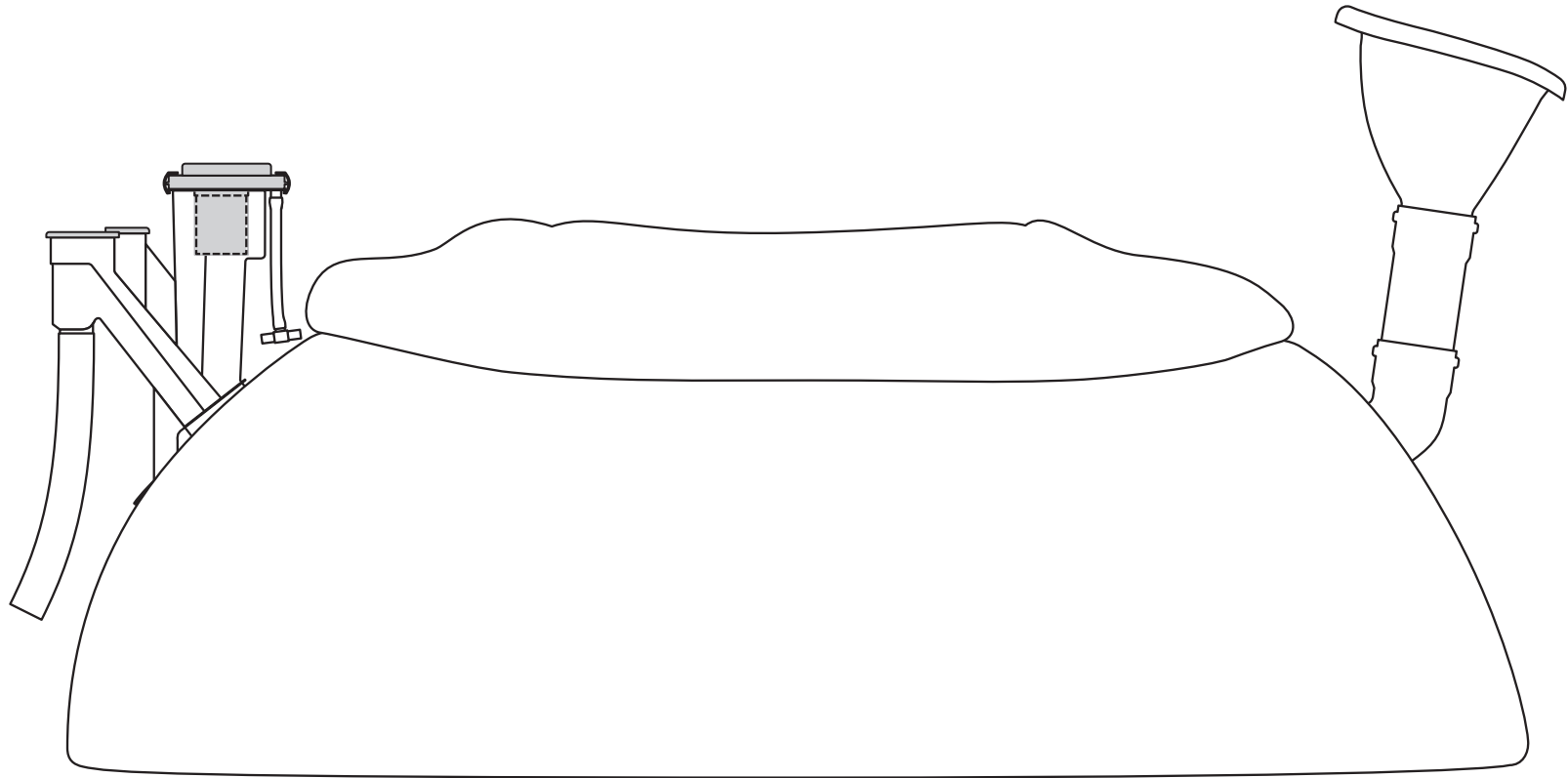

- i** remove 2 protective stickers from cover & around the base of gas filter



(gas filter)

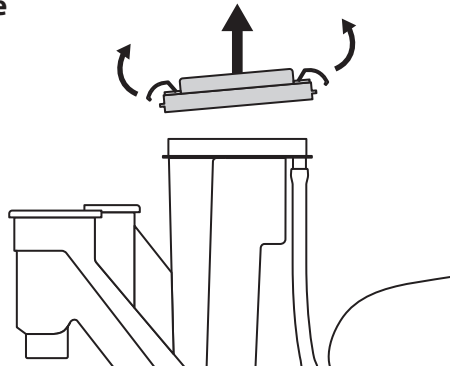

- ii**

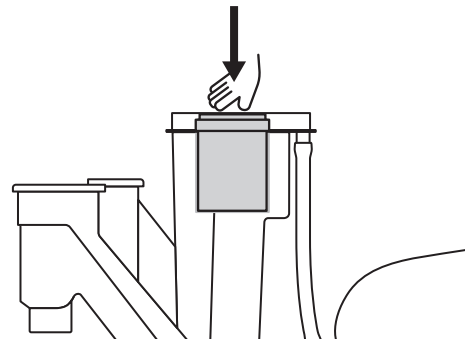

- iii**

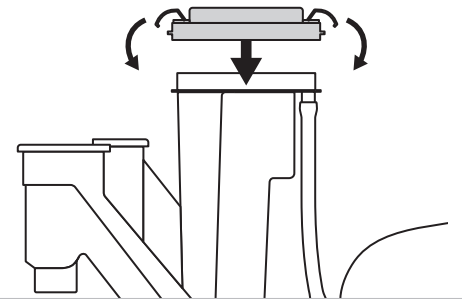





soften gas pipe in hot water for easy insertion of connectors

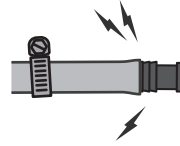

(212 °F)

(0.8")

2cm



10s



parts bag

x2

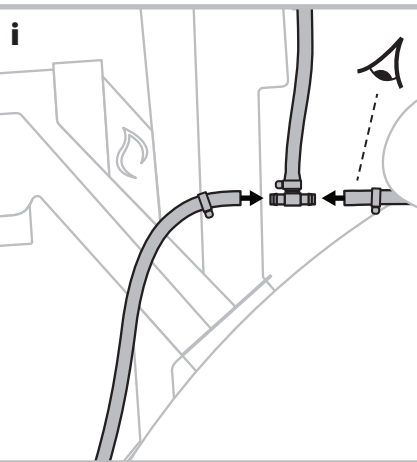
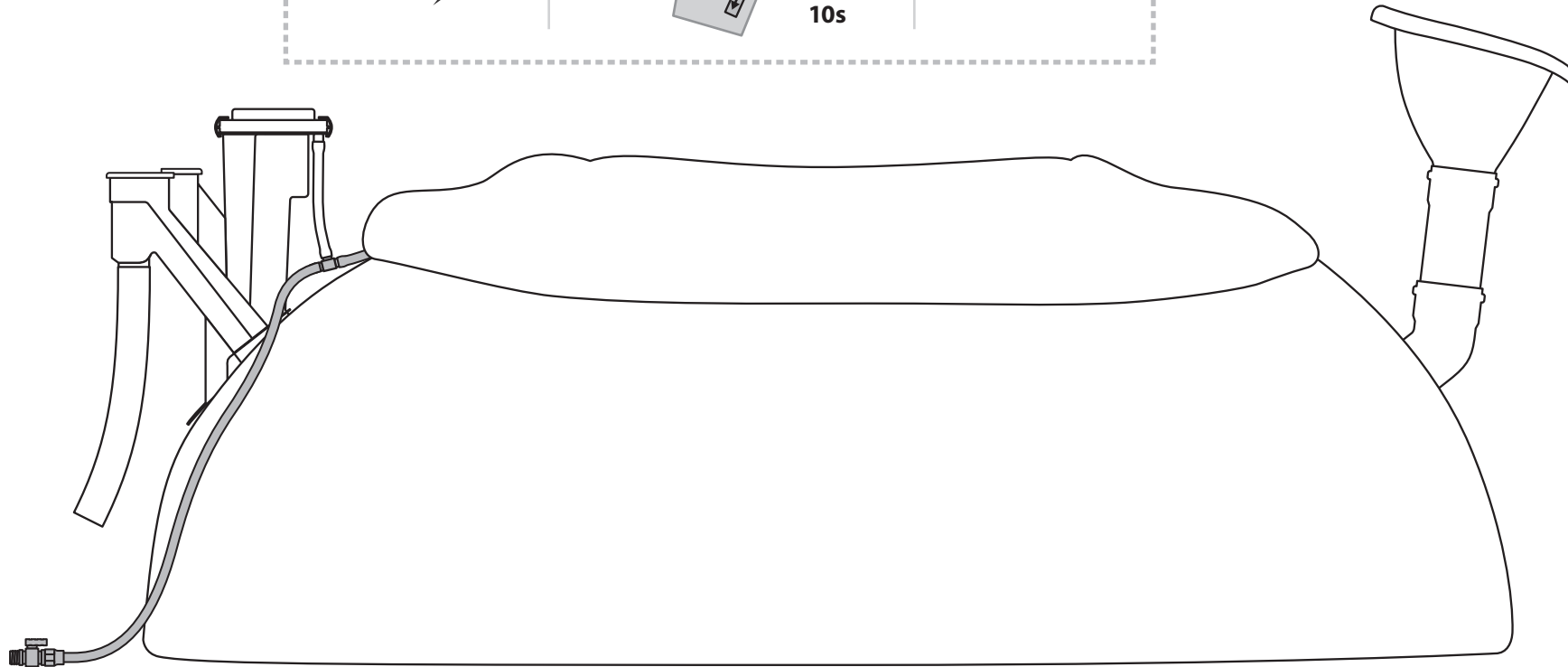

marking on gas tank outlet pipe must be facing upwards

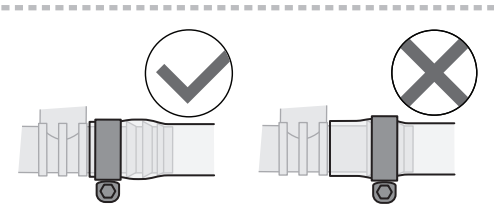
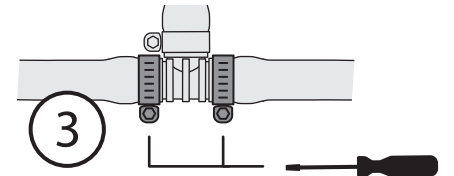
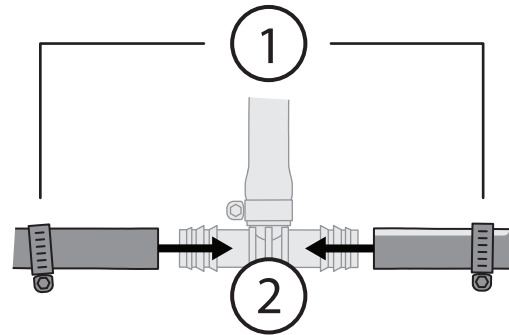
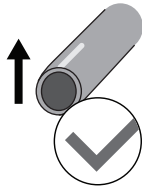

# gas pipe installation

## Installation Criteria & Guidelines

1. The length of gas pipe from the main valve to the stove can be up to 20m (65ft) in length (10m/33ft total piping provided with system).
2. The 10mm ( $\frac{3}{8}$ " ) gas pipe is meant for indoor use and should be installed as close to the stove as possible.

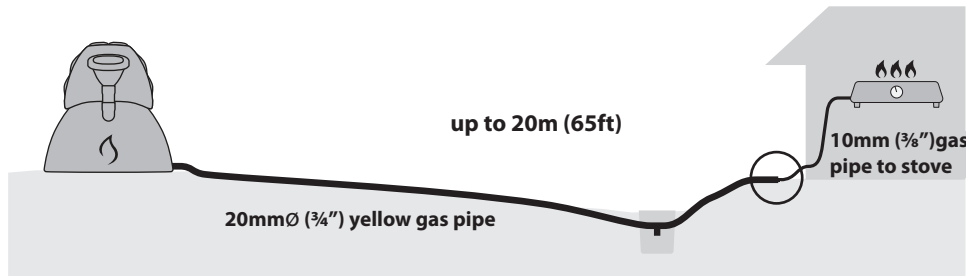

3. Condensation from biogas will collect in the gas piping. It is important to install the pipes at a continuous, slight angle from the system so that the water will flow towards the lowest point.

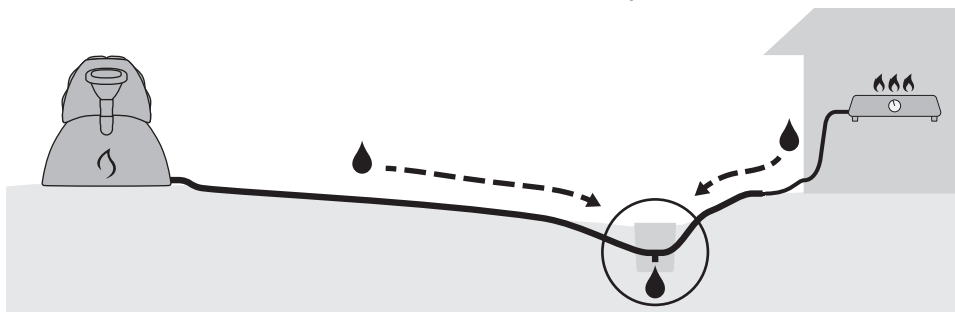

4. Water drainage outlet(s) should be installed at the lowest point(s) of the gas piping. (installation details on page 29)

5. All gas pipes should be stretched out/straightened along their routes. There should be NO U-shaped bends along the pipe, where water will collect and block gas flow.

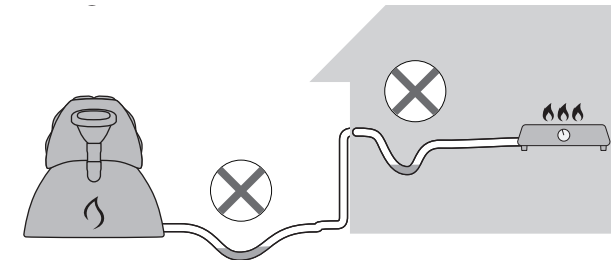

6. Cut gas pipe to the length required: do not coil the excess.

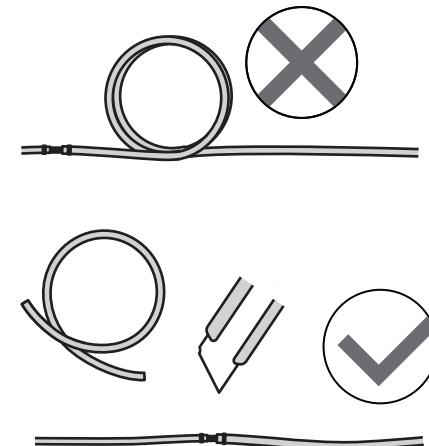

## Installation Options

Choose the installation method most suited to your system's location and surroundings. A combination of the different methods is possible as long as all the guidelines on page 26 are met.

### 1. Gas pipe installed underground



Pass gas pipe through a rigid pipe (PP/PVC 40mm/1½") for protection.

### 2. Gas pipe above-ground

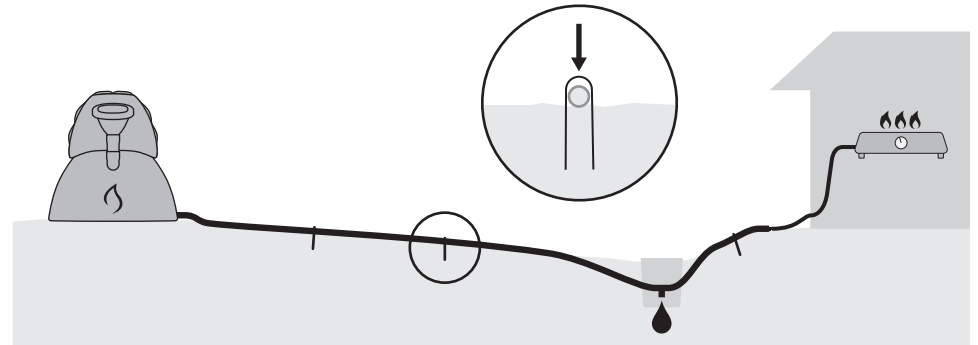

Anchor gas pipe to the ground with U-stakes provided.

### 3. Gas pipe fixed onto wall or nearby structure

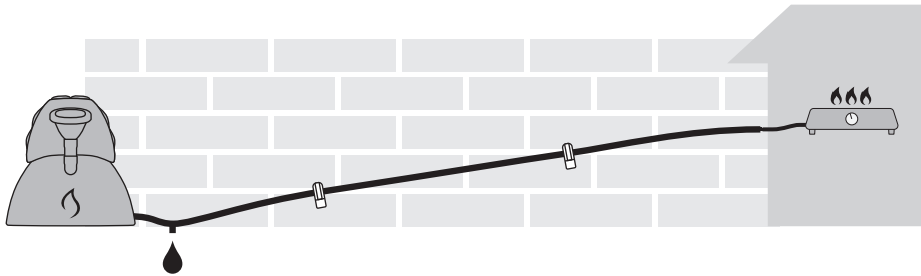

Use the wall clamps provided to secure gas pipe to the wall, to hold the pipe at the correct angle.

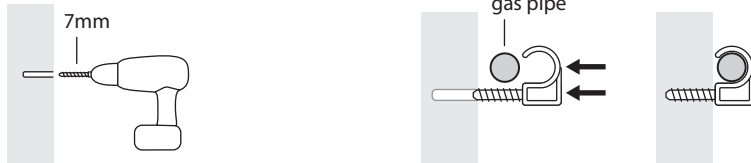

### 4. Gas pipe suspended on overhead line

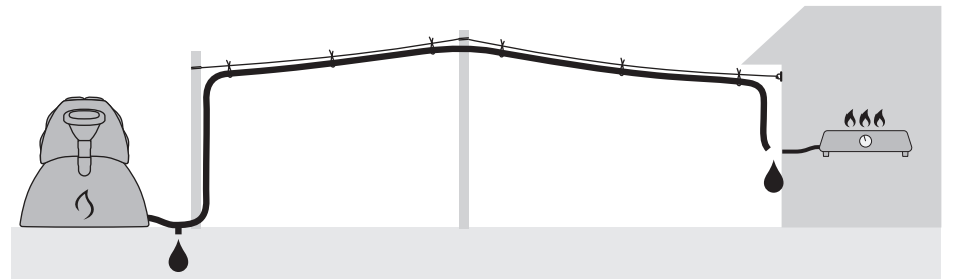

Install poles/structures of the required height, if necessary. Securely attach strong rope/cable (e.g. 4mm PP gardening twine) across the poles - take care to maintain constant slope across the line, with no low points. Suspend gas pipe from the line with wire (e.g. copper core electrical wire) at intervals along the pipe.



for all gas pipe fittings: soften pipe tip in hot water for easy insertion

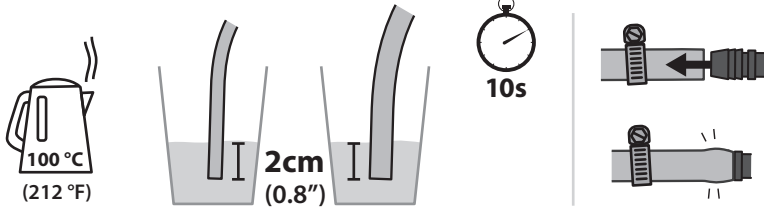

parts bag



purchase

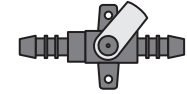

**x2**  
10mm (3/8")

iii

for indoors usage, connect an additional safety valve. (purchase separately with 2x 10mm/3/8" metal bands)

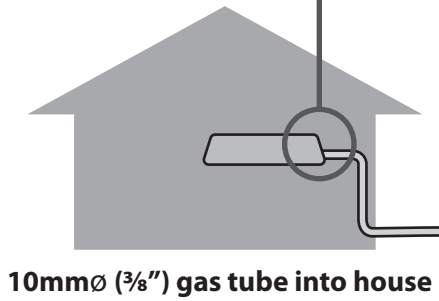
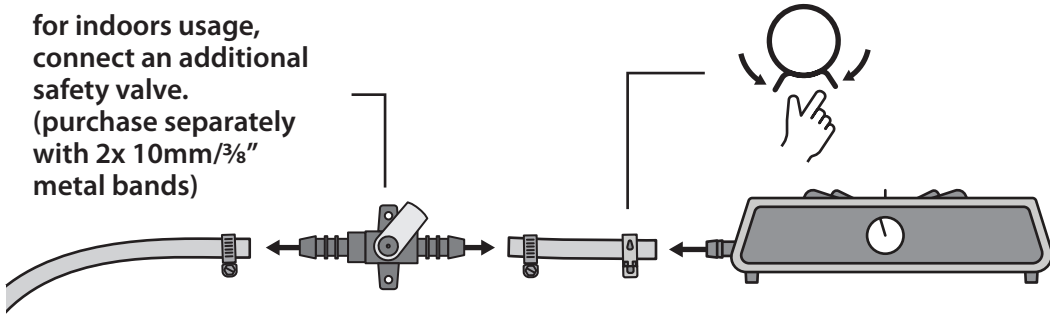

ii

20mm (3/4") to 10mm (3/8") reducer fitting

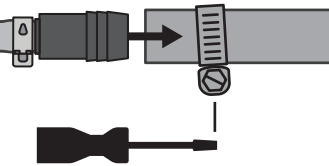

20mm Ø (3/4") gas tube from system

i

closed

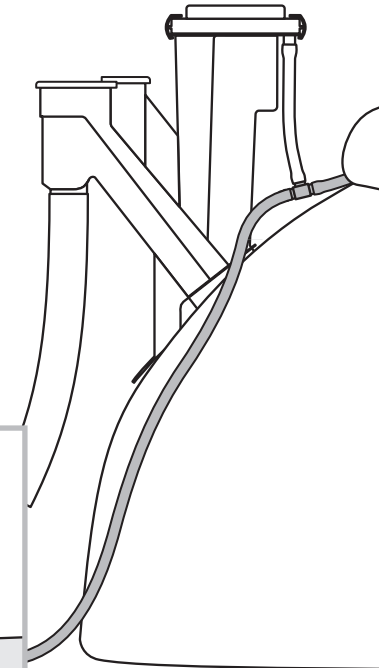

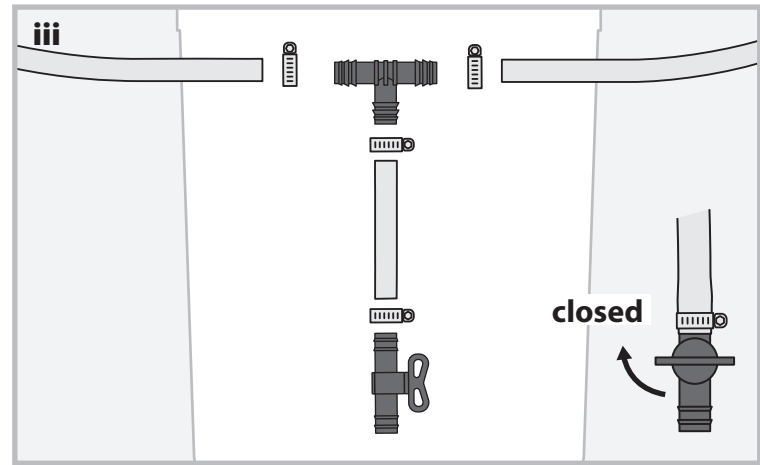
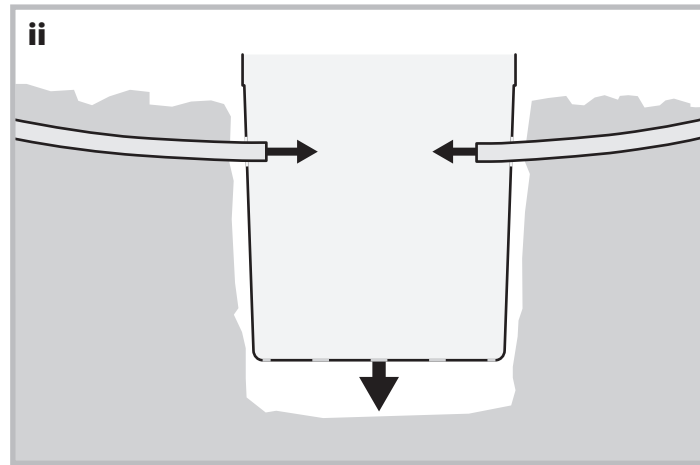
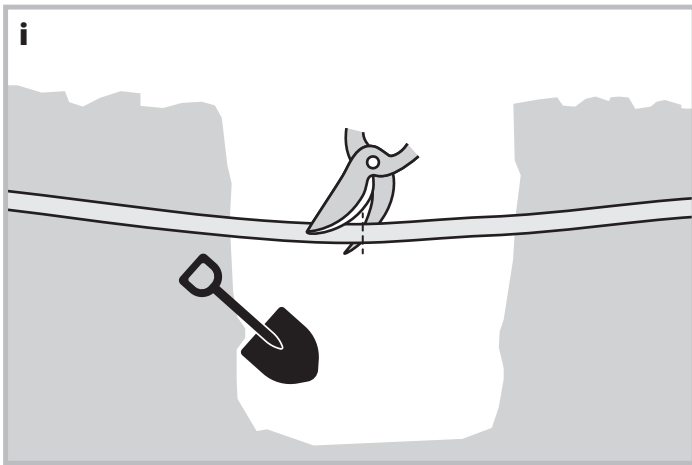
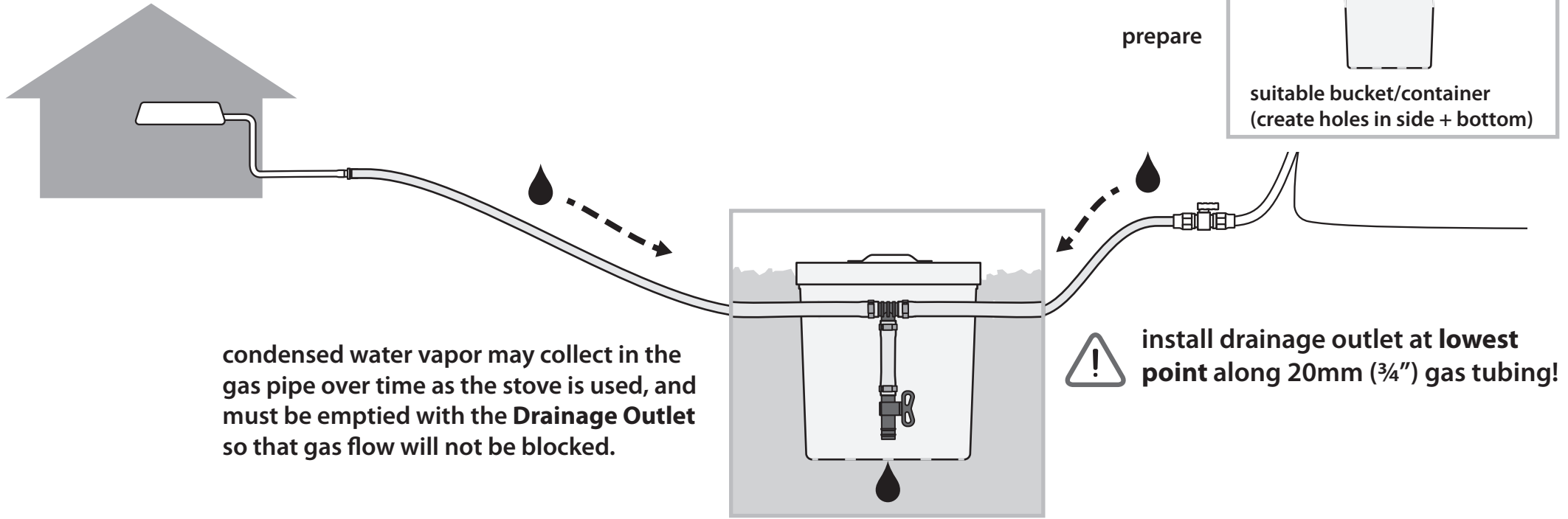
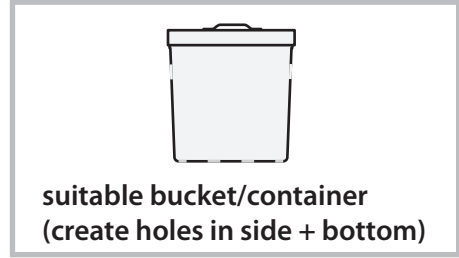
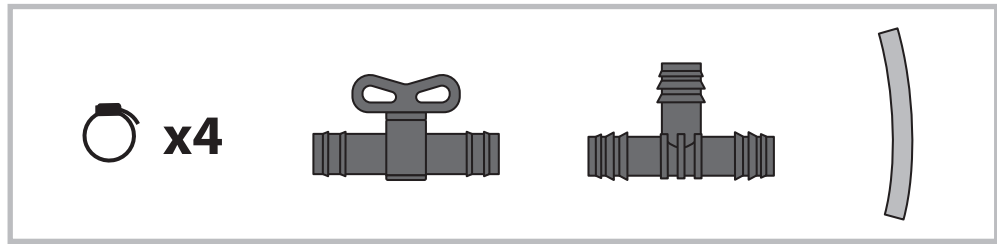



Please check your system with the following list and confirm that each item has been completed.

This will ensure your system functions smoothly and prevent potential system damage.

1. Gas Outlet Cap is pushed down completely and locking clips are fastened

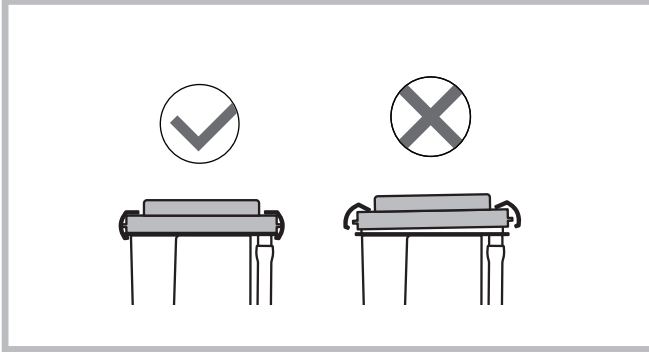

2. Waste inlet & Combined outlet inserted completely

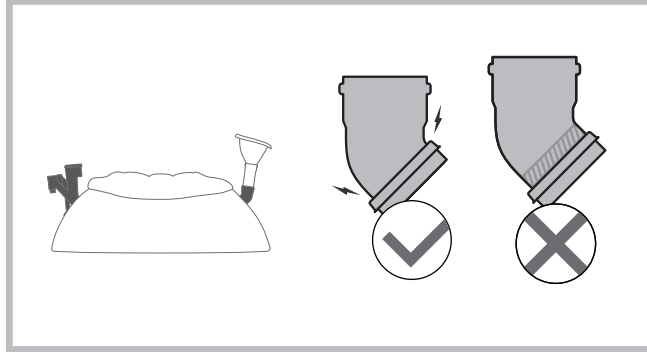

3. Sink connection pipe inserted fully

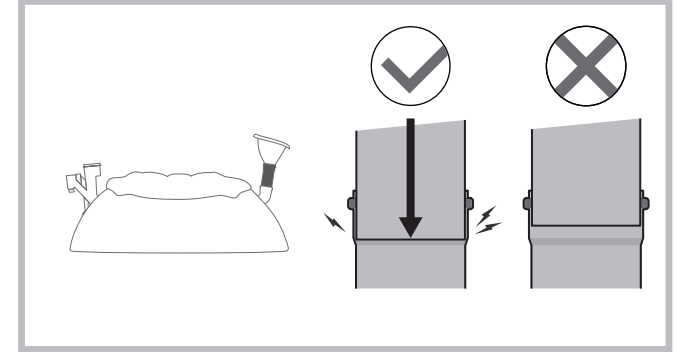

4. Sandbags inserted in correct locations (page 21)

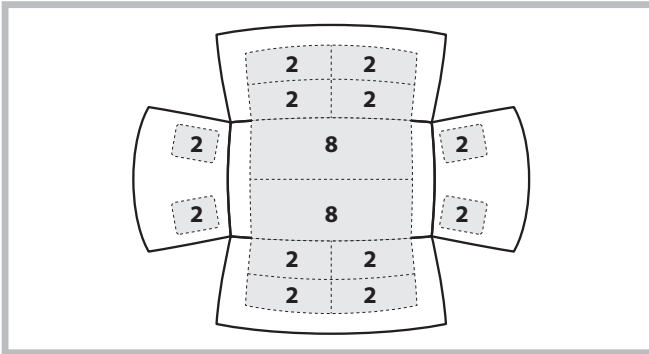

5. Sink anchoring cords correctly attached

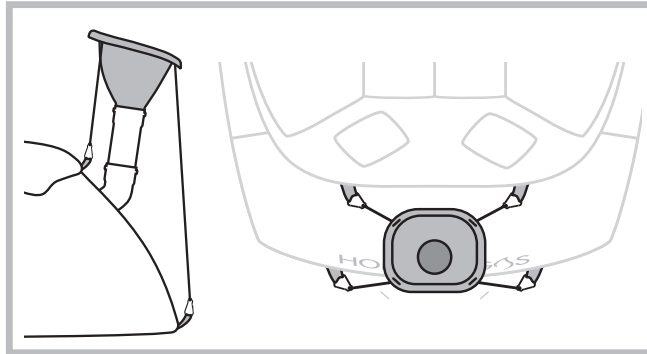

6. Steel bands on 20mm gas tube securely tightened

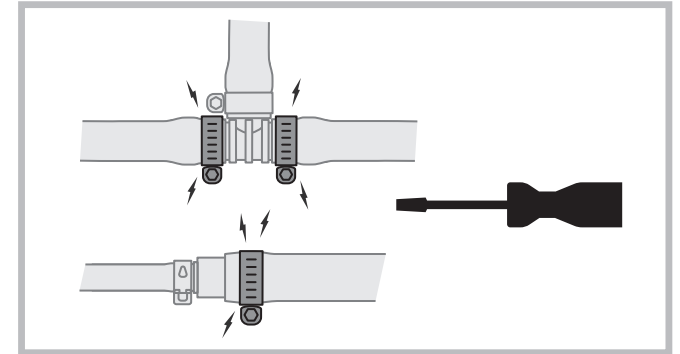

7. Gas valve closed (until activation complete) & gas valve on ground level

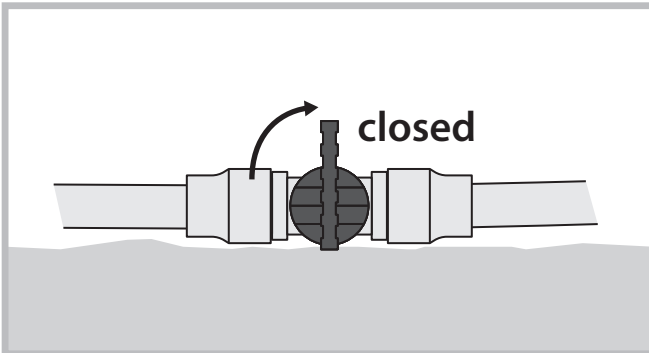

8. Water Drainage Outlet valve closed

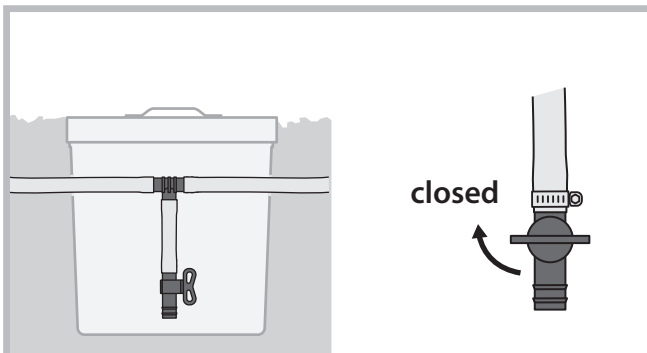

9. All gas connectors screwed tight

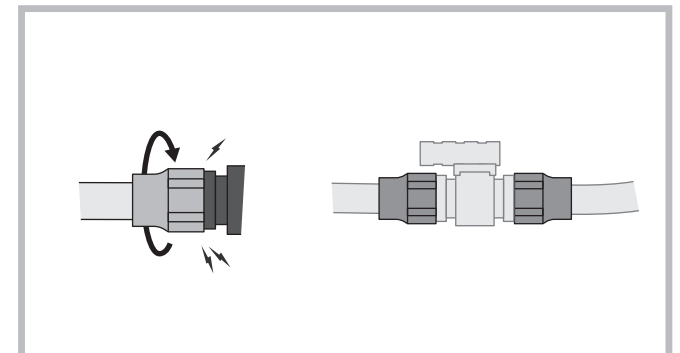

10. Digester filled until water flows from fertilizer outlet

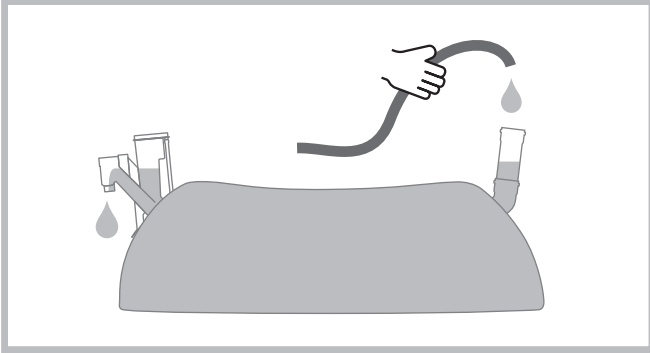

11. Digester is placed on strong, flat, level surface (refer page 7-8)

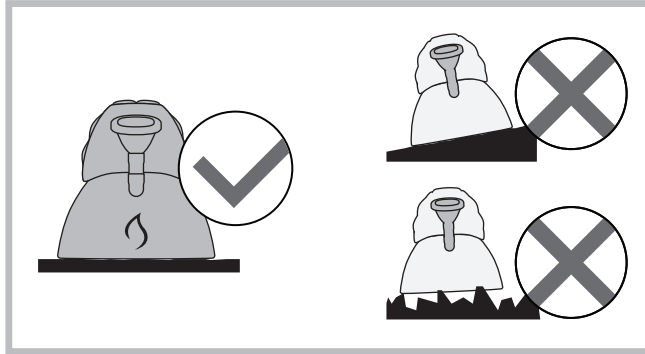

12. Digester is placed in sunny location near kitchen, away from windows/sitting areas (refer page 7-8)

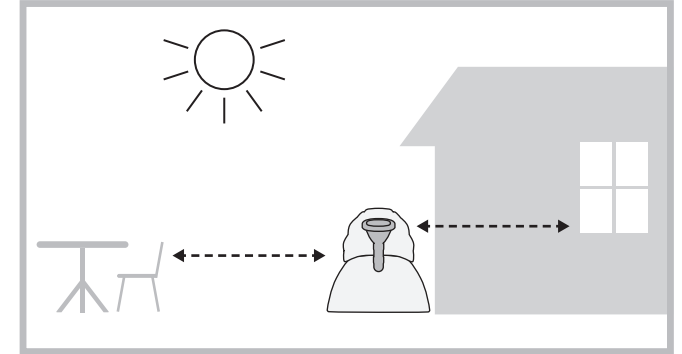

13. Marking on Gas Tank Outlet pipe is facing upwards

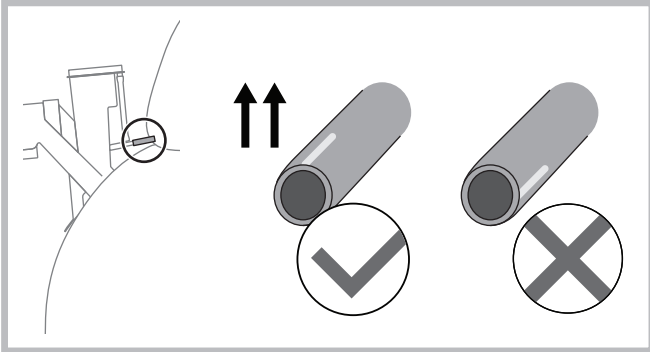

14. Combined outlet is aligned 90° vertically and not leaning in any direction

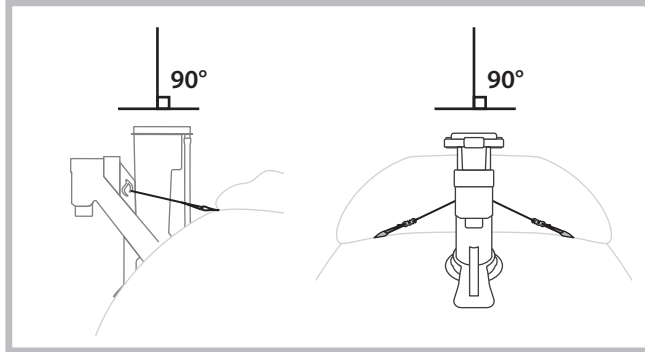

Please proceed to the next section to activate your system before use.  
**DO NOT** begin to feed the system before it has been activated.

# activating the system

**Wait a day after assembly and verify there are no leaks before starting activation.**

Activate the system in warm weather. (average day/night temperature at least 25 °C (77 °F) for the first 4 weeks).

To activate, you will need: 100 liters (25 gallons) of animal manure from herbivores, fresh (wet and up to 2 days old) & clean as possible from straw/stones/earth. Manure from cows, sheep, goats, horses or pigs can be used. Do not use chicken droppings. The 100 liters can be fed over a few days if it is difficult to obtain the full amount at once.

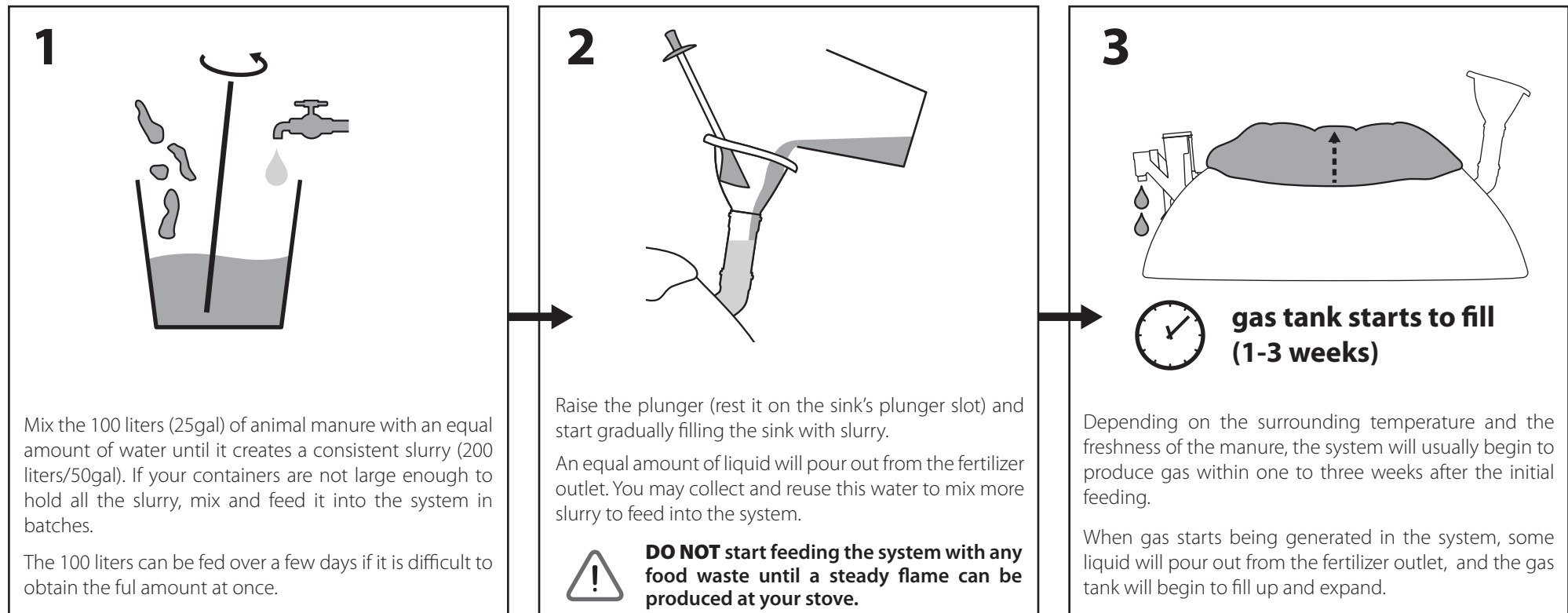



6

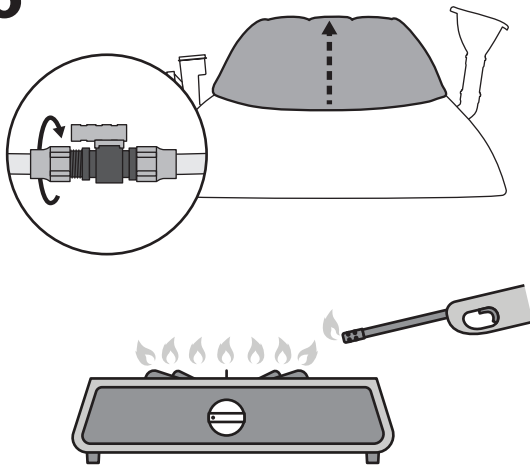

Close the Gas Valve's screw-on connector and wait for the tank to fill up again, then try to light the stove.

5

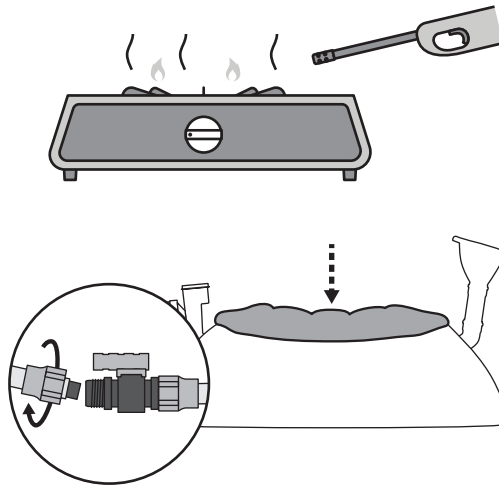

The gas produced at first may contain a high level of CO<sub>2</sub> and will not ignite easily

If the flame is not steady or the gas does not ignite, empty the gas tank by unscrewing the Gas Valve Connector until the gas tank has completely deflated. Initially, the storage tank may need to be emptied once or twice.

4

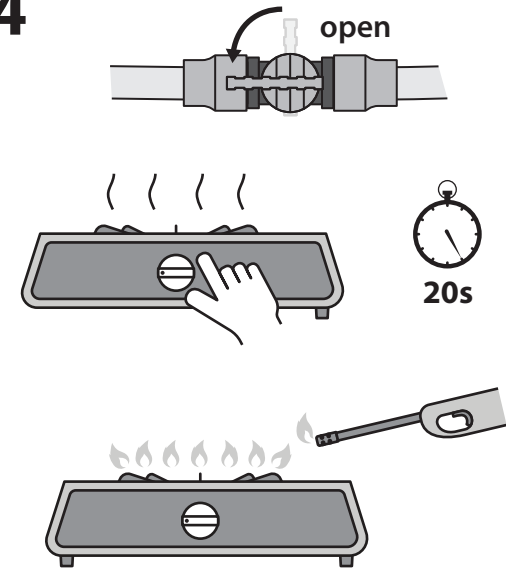

Once the gas tank starts to fill visibly, try lighting your stove. (first open the Gas Valve at the system)

For first time use, allow the air in the gas tube to escape for about 20 seconds (or more, depending on length of your gas tube) before lighting. (we recommend using a lighter, as biogas is less flammable than regular gas).

If you do not achieve a steady, reliable flame return to step 5 and repeat until a good flame is achieved.

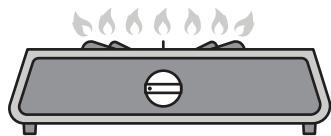

Once you are able to easily light a steady flame at your stove, the system is ready for use. At this point you may start to input food waste. **For the first two weeks, feed the system a maximum of 3 liters (0.8 gal) of food waste or up to 15 liters (4 gal) animal manure a day.**

# daily operation

## how to feed the system:

**1**

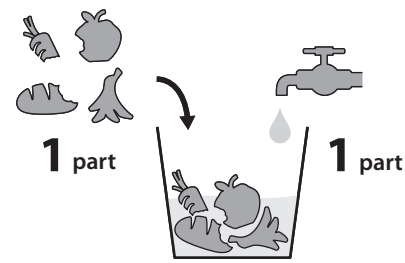

**Kitchen Waste:**  
Add an equal amount of water (by volume) to the kitchen waste.

**2**

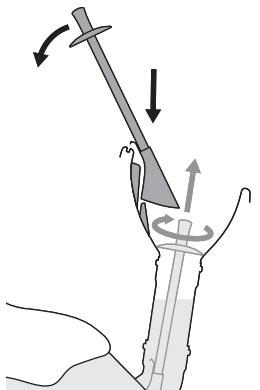

Turn the plunger 180°, then lift and rest the plunger on the plunger slot on the back of the sink.

**3**

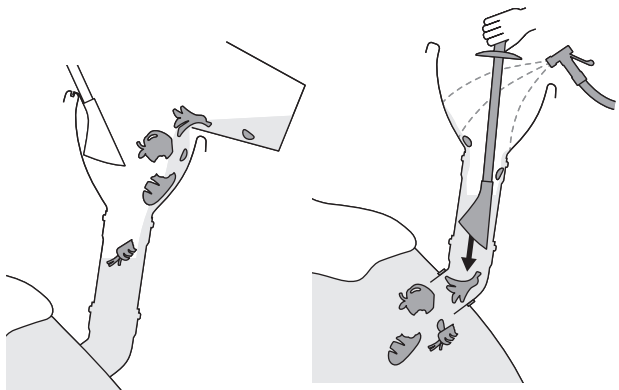

Pour the kitchen waste/manure slurry into the sink gradually to prevent splashing.

Push the waste down the inlet pipe into the digester tank, then rinse the sink (and container) with water.

**4**

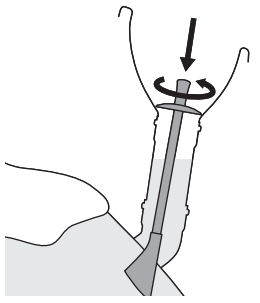

Push the plunger all the way down the inlet pipe, then make sure to turn plunger 180° to “lock” it in place and properly seal sink.

**Animal Manure:**  
Mix manure well with twice the amount of water to create a slurry. (1:2 ratio of manure to water)

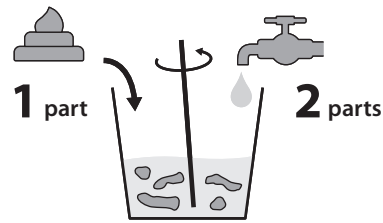

## what to feed the system:

Kitchen Waste	Animal Manure
up to 6 liters/2kg (1.5 gal /4.5lbs) per day	up to 16 liters/16 kg (4.2 gal/35lbs) per day <i>(16 liters manure + 32 liters water = 48 liters slurry)</i>
Food scraps like rice, cheese, vegetable & fruit peels/pulp, meat, bones, eggshells, cooking oil, and any other “wet” food waste. <b>Add an equal volume of water when feeding food waste.</b> <b>(1:1 ratio of waste to water)</b>	Animal waste, as clean as possible from stones, straw and earth. Dog or cat waste (free from sand) can be fed. <b>All types of animal waste should be mixed well with twice the volume of water (1:2 ratio of waste : water)</b>
<b>Combined Feeding:</b> It is possible to feed a combination of both food waste and animal manure. The maximum feeding volumes of both types of waste are allowed.	

### Control Feeding Amounts:

Cooking Oil (can lower system pH, slows digestion)	Chicken/Poultry Droppings (high ammonia content, can raise system pH)
max 50ml / 1.7oz per day	max 50% of waste input Example 1: 4ℓ kitchen waste + 2ℓ chicken droppings (+ 8ℓ water) Example 2: 8ℓ manure + 4ℓ chicken droppings (+ 24ℓ water)

## do not feed:

Restricted Food Waste	Garden Waste			Household Waste	
citrus fruits large seeds (e.g. mango, avocado seeds)	straw grass dry leaves	twigs tree branches wood shavings	earth sand	metal plastic glass	paper any non-organic liquids

## Using Liquid Fertilizer

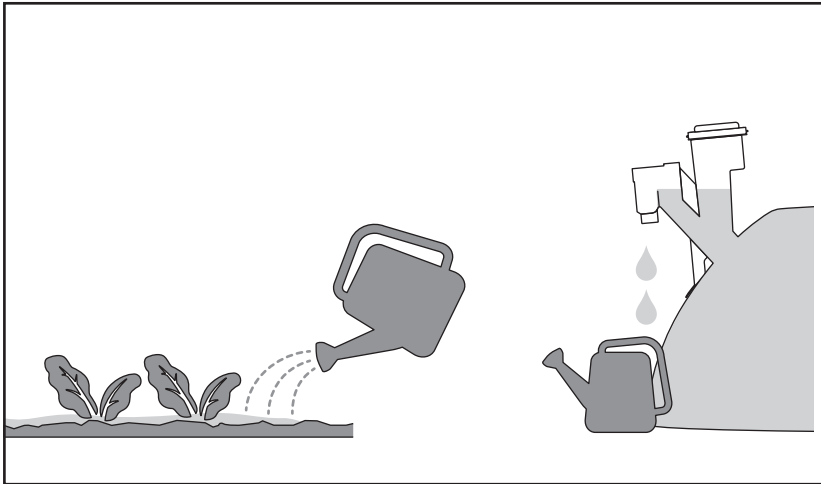

The fertilizer produced by the HomeBiogas system may be safely used on your vegetable patch, flower beds or fruit trees etc. It can also serve as a water and nitrogen additive for a compost heap.

For watering small plants or new trees, dilute fertilizer to **5:1 parts water to fertilizer.**

Detailed information about the liquid fertilizer can be found on page 45.

## Cold Weather Operation

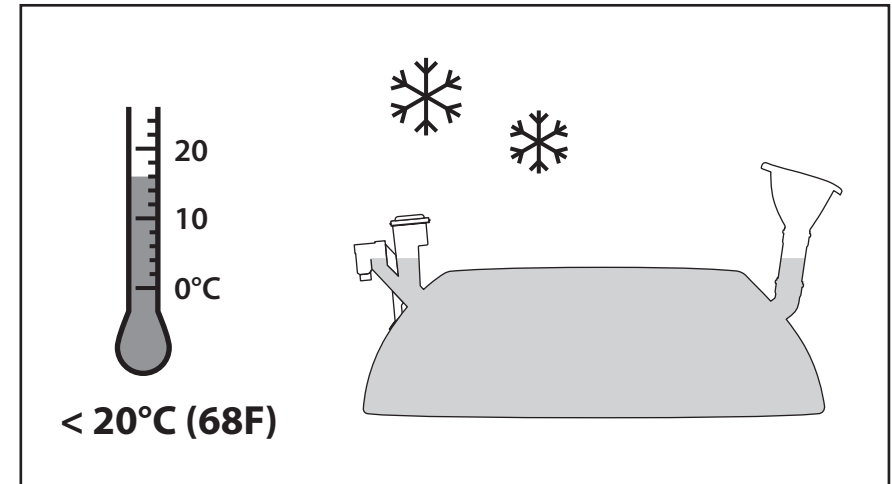

Gas production will slow down when the system's average surrounding temperature drops below 20 °C (68F). Feeding the system at average temperatures below 20°C may lower the pH of the system and cause system failure!

If the system is fed with kitchen waste or a combination of animal manure and kitchen waste, **stop feeding when the average temperature drops below 20°C/68°F.**

If the system is only fed with animal manure, **stop feeding when the average temperature drops below 15°C/ 59°F.**

If temperatures will drop below freezing, you may drain at least 200 liters of liquid from the system and reactivate it (page 32) when warmer weather comes.

Visit [homebiogas.com/faq](http://homebiogas.com/faq) for more information on heating instructions and solutions, or contact HomeBiogas if you have additional enquiries.

# system care

## frequent care

**Make sure that the digester tank is completely filled with water.**

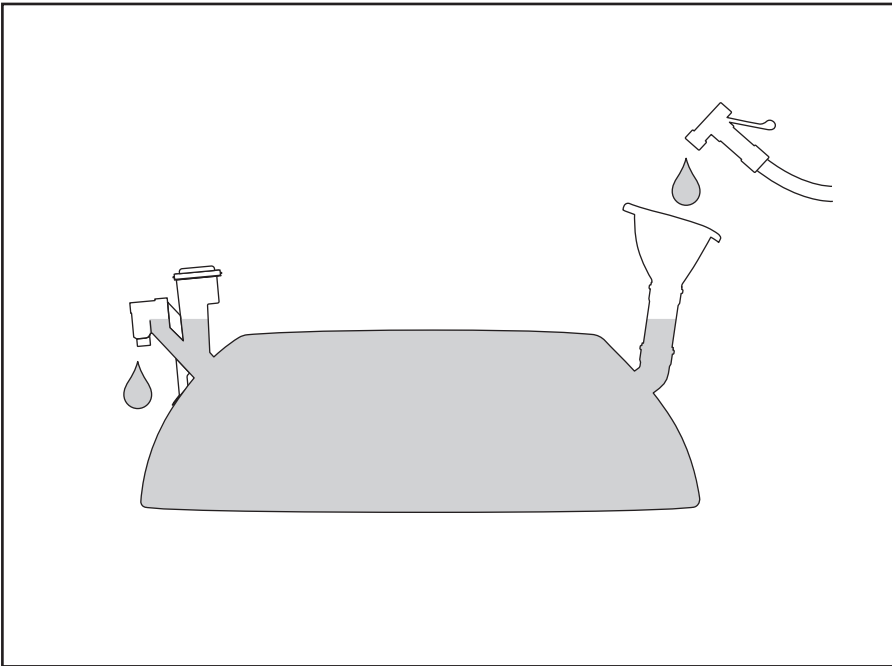

When the tank is filled, liquid should pour from the fertilizer outlet when the system is fed.

**Empty the condensed water accumulated in the gas pipes.**

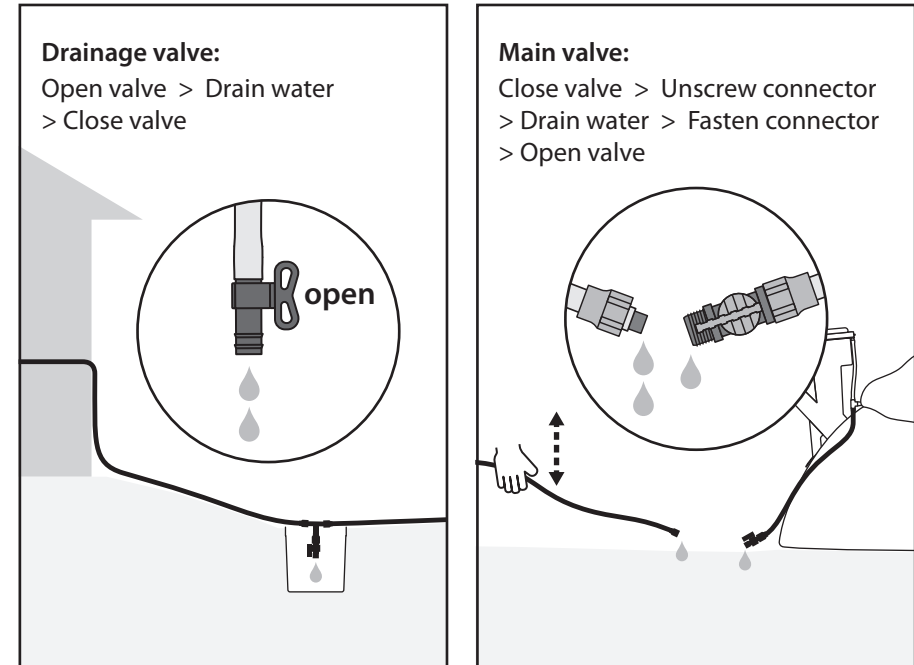

Biogas contains water vapor that may condense during cooler nights and accumulate in the gas pipes, blocking gas flow. If your stove's flame is sputtering, you should empty the water from the gas pipes. (Refer troubleshooting section on p40 for more details)  
You may need to raise or shake gas pipe to make sure all the collected water flows to the drainage opening.

## Agitate the digester tank around the inlet sink area

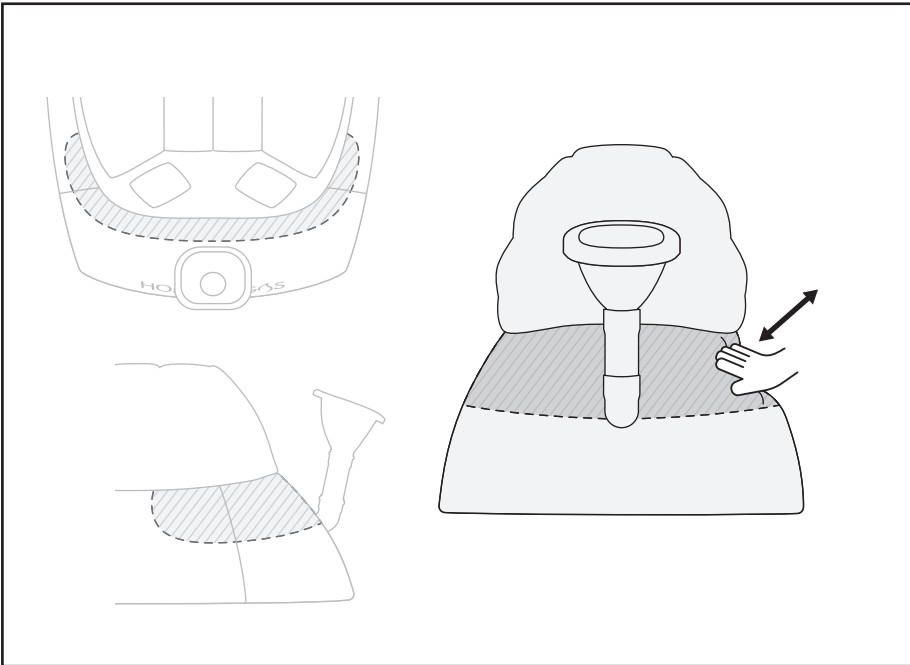

Once weekly, agitate or 'massage' the top part of the digester tank, all around the front (inlet sink) side of the digester. The agitation process improves digestion efficiency and helps move solids towards the back of the tank.

To agitate, use both hands to firmly push and release a few times on the digester tank. Repeat the action along the entire area marked in the images above.

## periodic care

\* System components are rated for 10-year lifespan. After 10 years check materials and contact HomeBiogas for replacement parts if required.

### Replacing the Gas Filter

Every 6 months / when gas burns with unpleasant odor  
(failure to replace filter will result in warranty loss!)

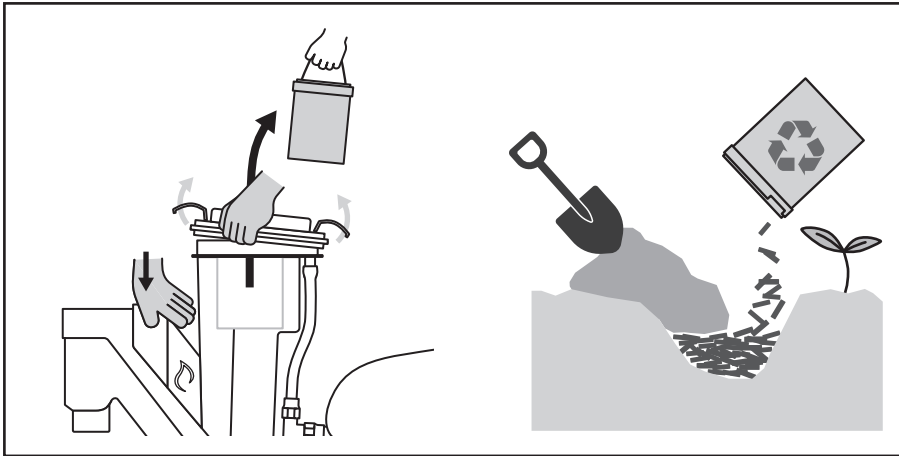

**Contact the company or your distributor for a new filter.**

#### Remove the filter and dispose of used filter media

1. Use or release the gas from the system until the gas tank is empty. (To keep gas, block the gas duct while removing filter and place outlet cap back on)
2. Release the locking clips, hold down the Combined Outlet securely and lift the Gas Outlet Cover.
3. Remove the Gas Filter by the cord handle attached to the filter's cover.
4. Properly dispose of the spent filter media by burying it underground as a soil improver, or add it to compost. Take care not to breathe in vapors from the filter media. Rinse and recycle the empty container.

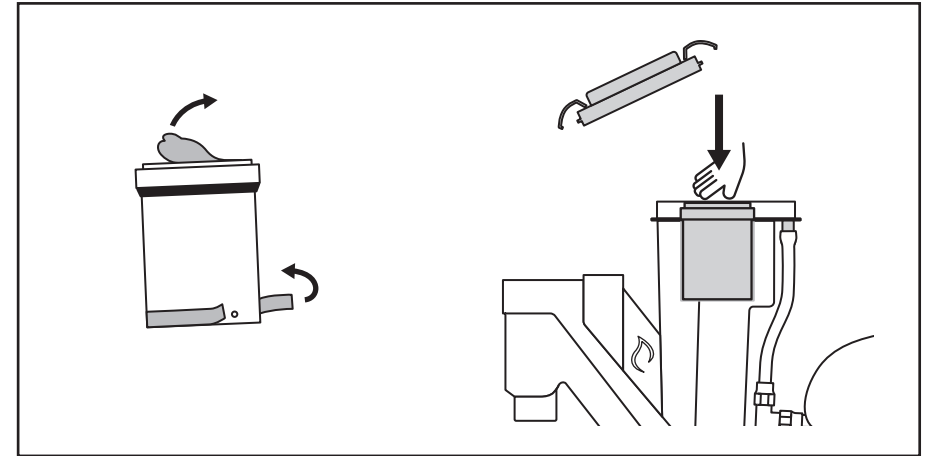

**Install the new filter:**

1. Remove the 2 protective stickers from the top and around the base of the new filter.
2. Place the filter into its slot in the gas outlet - make sure to push the filter down completely.
3. Replace the Gas Outlet Cover, pushing it down securely, and press the cover locking clips back into place.

# troubleshooting

## No gas at the burner, and the gas tank is empty

- 1. Gas valve was left open.**  
 Check if system gas valve, drainage connector or stove's gas valve have been left open, allowing the gas to escape. ensure stove is turned off, gas valve is closed and drainage connector is screwed shut.
- 2. System has not been fed for some time.**  
 Feed the system.
- 3. Water level in the digester tank has fallen too low allowing gas to escape through sink.**  
 Fill the digester tank with water until you see liquid pouring out of Fertilizer Outlet.
- 4. Cold weather caused bacteria to stop gas production.**  
 Reduce feeding volumes (refer to cold weather operations on page 34) or wait for the weather to warm up.
- 5. There is a gas leak somewhere in the system or along the gas tubes.**  
 To locate leak, apply soapy water along the gas pipes, tank flanges and pipe joints. Leakage will cause bubbles to appear. Fix the leak or replace the leaky element.
- 6. pH level in the system is abnormally low (<5.0), causing gas production to stop (see page 39 for details on pH checking).**  
 Contact HomeBiogas for assistance.

## Gas tank is filled but there is no gas flow, or flame sputters and dies frequently

The most likely cause is accumulation of water condensation in the gas pipe, blocking the free flow of gas to the stove.

Ensure there are no bends/dips in the pipe from stove to system that water can collect in. The gas pipe should also be installed at a slight angle from the system to the stove.

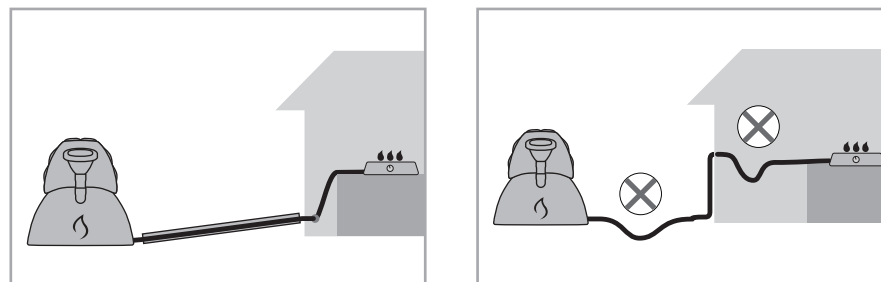

### 1. Drain collected water from the gas pipes.

- Open the water drainage valve and drain any collected condensation from the gas tube (refer p38).
- If problem persists, you may need to empty the 10mm ( $\frac{3}{8}$ " ) gas tube separately - open clamps, disconnect the 10mm ( $\frac{3}{8}$ " ) gas tube from the reducer fitting and stove and drain out any water from the tube. Blowing through the tube or using an electric air pump to pass air through the tube will help to clear out collected water.
- Close drainage connector and reopen gas valve.



## Tank is filled, gas flows out but does not burn, or flame dies after a few seconds

The system may be producing more CO<sub>2</sub> than methane due to low pH values in the digester.

6.0 - 6.5	<b>150 liters (40 gal)</b>
5.5 - 6.0	<b>300 liters (80 gal)</b>
5.0 - 5.5	<b>450 liters (120 gal)</b>
< 5.0	<b>contact homebiogas</b>

**Try to allow the system's pH to stabilize itself.**

- i. Empty the gas tank through the Drainage Connector. Close the connector once the tank is empty.
- ii. Stop feeding the system for a week. On the 3rd day, try to light a flame. If the gas does not burn, empty the gas tank again and close the Drainage Connector.
- iii. After a week, try to light a flame again. If the flame still does not burn you may need to increase the system's pH.

### 1. Measure the system's pH level with a measuring kit (bought separately) and add fresh manure to the system.

- i. First drain at least 2 liters (0.5gal) of water from the fertilizer outlet, to get a "fresh" sample of liquid from the digester tank. Then, take a sample of liquid from the fertilizer outlet.
- ii. Follow the instructions that come with your pH measuring kit to test pH level of the sample. (Reduce 0.2 from the pH test reading if you have a chlorine tablet installed.  
If the system's pH is lower than 6.5, add fresh manure to the system and mix well with plunger, according to the pH level measured: (prepare suitable containers/piping to drain away the digester liquid which will flow out when adding the manure.)

- iii. Wait for 4 hours and then measure the pH level again - if it is still below 6.5, repeat the previous step and add more sodium bicarbonate.

### 2. If pH level is above 6.5, let gas accumulate and try to light it. If gas is flammable, resume feeding and using the system.

### 3. If gas is not flammable: empty the gas tank, allow gas to accumulate for a day and try to light again.

(Note: Adding sodium bicarbonate makes the system generate carbon dioxide (CO<sub>2</sub>) which may make the initial gas collected non-flammable).

- i. Do this for 5 days till you have flammable gas.
- ii. If 5 days have passed and you still do not have flammable gas, the system may not have enough organic material to produce gas. Add 40 liters of fresh animal manure and try to light the gas after a week.

**If the system still produces non-flammable gas after carrying out the previous steps, please contact us at [support@homebiogas.com](mailto:support@homebiogas.com).**

## No flow of fertilizer from the Overflow pipe, and high water level in the sink

The fertilizer drain pipe may be clogged at the fertilizer outlet.

Open the fertilizer outlet cover, and check for any blockages caused by an accumulation of floating material. Dislodge the blockage with water and a suitable tool.

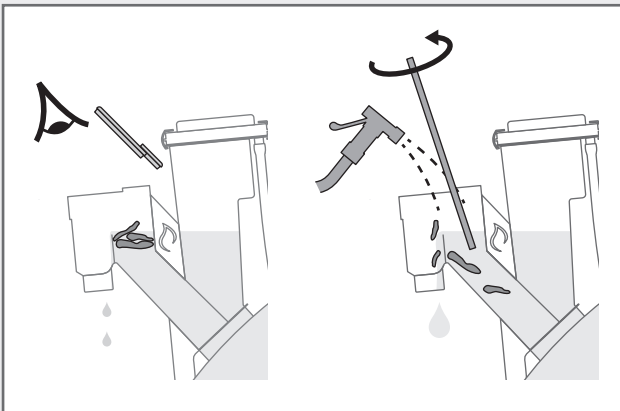

## Waste cannot go down inlet pipe when feeding

Solid waste is blocking the sink drain or a build-up of waste below the sink drain is preventing the feeding of waste.

Try to push down the blockage with the plunger. This can also be done using a wooden broomstick or long object to gently push the blocking matter into the digester tank, while running water into the sink to help clear the blocked matter.

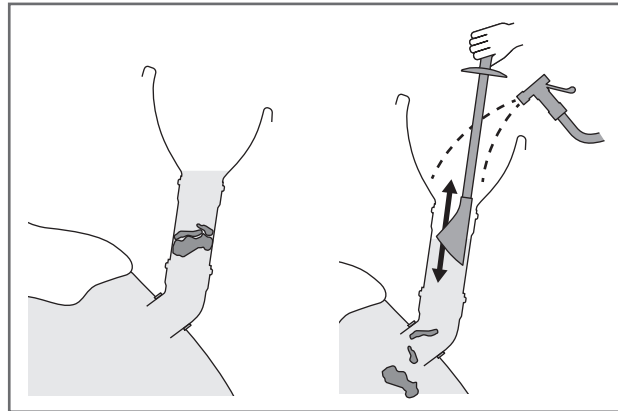

## System is producing bad odors

- 1. Sink may not be properly sealed by plunger.**  
 Make sure the plunger is turned 180° after inserting it fully, so that the sink is sealed and smells cannot escape. If the plunger still floats upwards, you may need to weigh it down with a rock/other heavy object.
- 2. Bad smell when gas is used.**  
 Remove the gas outlet (G) cap, pull out the Gas Filter and check that the filter's rubber seal is in place, fitted into the filter's lip. (Replace the filter with a light downward push for a good seal)  
 If the rubber seal is fine, your filter should be replaced. Contact Homebiogas or your local distributor for a replacement.
- 3. Fertilizer smells bad.**  
 It is normal for the system's liquid to have a mild fermenting/'organic' smell from the broken down waste (depending on what the system is fed) - the smell is usually detectable only when feeding the system or handling the fertilizer.  
 If you find this smell unpleasant, you can use a container with a small/enclosed opening for the fertilizer outlet sleeve to collect the fertilizer. Alternatively, you can pass the fertilizer through wood chips with a 2" pipe to eliminate the smell. However, if the fertilizer smells abnormally bad, refer to option 3.
- 4. Digester tank liquid smells bad.**  
 The pH of the system could be low (a joint symptom is poor gas flammability). Check the pH of the system and add manure if necessary (refer page 41)



# tech specs

## HBG 2.0 household biogas system technical specifications:

System volume	2.0m <sup>3</sup>	70ft <sup>3</sup>
Dimensions Assembled (L x W x H)	210 x 115 x 125cm	6.9 x 3.8 x 4.1ft
Weight Assembled (approx.)	1525kg	3362lbs
Gas pipe max length	up to 20m	65ft
Nominal gas pressure	10mbar	0.145psi
Max energy capacity	4.4 kWh/15.4 MJ	4.4 kWh/15.4 MJ
Daily cooking time (single flame burner)	up to 2 hours	up to 2 hours
Daily kitchen waste input	up to 6ℓ / 2kg	1.5 gal / 4.5lbs
Daily animal manure input	up to 16ℓ (48ℓ slurry)	4.2gal (12.7gal slurry)
Daily fertilizer output (same as input)	up to 48ℓ	up to 12.7gal
Operating temperature	>20°C	>68°F

# HomeBiogas fertilizer

HomeBiogas fertilizer is a high quality liquid fertilizer produced from HomeBiogas systems. When applied, the fertilizer can accelerate plant growth and increase resilience to diseases. The fertilizer is essentially the discharge from the digester tank. This discharge, the result of a long digestion process, is packed with various microbes, biostimulates, and organic nutrients in the right form for rapid absorption by plants. The presence of both macro & micronutrients makes HomeBiogas fertilizer a good choice for most gardening and small-scale agricultural purposes.

## FEATURES

HomeBiogas fertilizer has the following properties that differentiates it from many commercial fertilizers:

- Contains many macro and micronutrients for a more well-rounded fertilizer.
- Nutrients exist as solute in the fertilizer, and have high absorption and low leaching rates.
- Liquid form allows quick, easy application onto plants.

## PROPERTIES

Nitrogen	260mg/L
Phosphorus	20mg/L
Potassium	275mg/L
Macronutrients present	Ca, Mg, S
Micronutrients present	B, Cu, Fe, Mn, Zn, Cl-, Mo, Na, Ni
E. Coli	<10 cfu/100mL*
Fecal Coliforms	<10 cfu/100mL*
E. Coli O157:H7	none
L. Monocytogenes	none
Salmonella	none
V. Cholerae	none

*\*less than 10 colony-forming units - practically undetectable in laboratory numbers*

Each biogas system produces fertilizer with slightly different nutrient contents, depending on the kind of organic matter fed to the system and its bacterial substrate.

The manual's fertilizer usage instructions accounts for this potential variation - however, when using the liquid fertilizer, attention should be paid to the appearance and health of the soil and plants. Reduce feeding volumes or stop applying fertilizer if plant health is negatively affected.

## APPLICATION METHOD

HomeBiogas fertilizer can be applied to plants via two methods: root drench or foliar spray.

- Root drench: pour fertilizer directly into surrounding soil.
- Foliar spray: use a spray bottle to spray fertilizer onto plants' leaves.

## APPLICATION RATE

The fertilizer should be diluted in a ratio of 1:5 (fertilizer : water) before use. For adult trees use dilution rate of (1:3).

The following is a suggestion for rate of application to plants.

- Flowers: 3.5 litre (1 gal) weekly per plant.
- Trees: 15-20 litre (4-5 gal) weekly per plant.
- High-nutrient-need vegetables: 5-10 litres (1.3-2.6 gal) weekly per m<sup>2</sup>.
- Low-nutrient-need vegetables: 3-5 litres (0.8weekly per m<sup>2</sup>).

Contact our Support Team at [support@homebiogas.com](mailto:support@homebiogas.com) to receive a complete manual on fertilizing the soil with the HomeBiogas Fertilizer!

## HOMEBIOGAS HBG 2.0 LIMITED PRODUCT WARRANTY

**This warranty is provided by HomeBiogas LTD. in connection with the purchase of the HomeBiogas HBG 2.0 Household System (the “System”).**

1. Warranty Description. HomeBiogas warrants to the Customer that for 24 months after the delivery of the product to the customer, the company shall provide, free of charge, a replacement for any part that is faulty or has failed.

1.1 Subject to assembly and use per the Company’s Manuals and under normal use and service, the System shall be in compliance in all material respects with the specifications thereof at the time of delivery to Customer and for a warranty period of twenty four (24) months from the date of delivery to Customer (the “Warranty Period”) shall be free from defects in workmanship and materials.

1.2 During the Warranty Period, HomeBiogas shall repair or replace at its option and expense any part which fails to comply with the Warranty specified above in Sections 1.1 Shipment of the replacement parts to Customer’s original destination shall be at the expense of the Customer. Notwithstanding the above, the final determination whether a part is defective shall be made by HomeBiogas.

2. Limitation on Warranties. Warranties and Customer’s remedies hereunder are solely for the benefit of Customer and shall not be extended to any person whatsoever. Customer shall be solely responsible for the selection, use, efficiency and suitability of the System. This warranty shall not apply to any System or related items if HomeBiogas’ testing and examination describes that the alleged defect or non-conformity does not exist or, that:

- (i) have been used with accessories and appliances not compatible with biogas;
- (ii) have been damaged by improper installation, operation, maintenance, misuse, accident, neglect, fire, lightning, or other peril, failure to continually provide a suitable operating environment, or from any other cause beyond HomeBiogas’ reasonable control, including Force Majeure events (as described in the General Conditions);
- (iii) have been used in a manner not in accordance with the instructions supplied by HomeBiogas and/or the General Conditions;
- (iv) have been subject to the opening of any sealed components without HomeBiogas’ prior written approval;
- (v) have had changes made by Customer or Customer’s representatives to the physical, mechanical or interconnection components of the System supplied by HomeBiogas without written authorization of HomeBiogas to do so; or
- (vi) have been repaired or otherwise altered by anyone not under the control of, or not having the written authorization of HomeBiogas to do such repair or alteration; or
- (vii) have been repositioned from its original location of set-up, or otherwise relocated; and
- (viii) does not apply to any cosmetic damage such as scratches or dents; and
- (ix) does not apply to any consumables or perishables.

3. Warranty and Post-Warranty Services. All warranty and post warranty services to the Systems shall be performed only by HomeBiogas, or by any entity appointed by HomeBiogas. This Warranty does not cover any installation, training or service charges.

4. THE WARRANTIES PROVIDED IN THIS WARRANTY DOCUMENT CONSTITUTE HOMEBIOGAS’ SOLE AND EXCLUSIVE LIABILITY FOR DEFECTIVE OR NONCONFORMING SYSTEM AND SERVICES AND SHALL CONSTITUTE CUSTOMER’S SOLE AND EXCLUSIVE REMEDY FOR DEFECTIVE OR NONCONFORMING SYSTEM AND SERVICES. THESE WARRANTIES ARE IN LIEU OF ALL OTHER WARRANTIES EXPRESS, IMPLIED OR STATUTORY, INCLUDING, BUT NOT LIMITED TO, IMPLIED WARRANTIES OF MERCHANTABILITY OR FITNESS FOR A PARTICULAR PURPOSE, AND ARE IN LIEU OF ALL OBLIGATIONS OR LIABILITIES ON THE PART OF HOMEBIOGAS FOR DAMAGES.

5. For service, contact HomeBiogas or the HomeBiogas certified reseller of the Systems specifying the model number and the serial number indicated on the nameplate that is affixed to the System’s frame.



